

RTA

Round Tapered Aluminum Pole with Arms Triple Cross Arm 120° — Breakaway T-Base

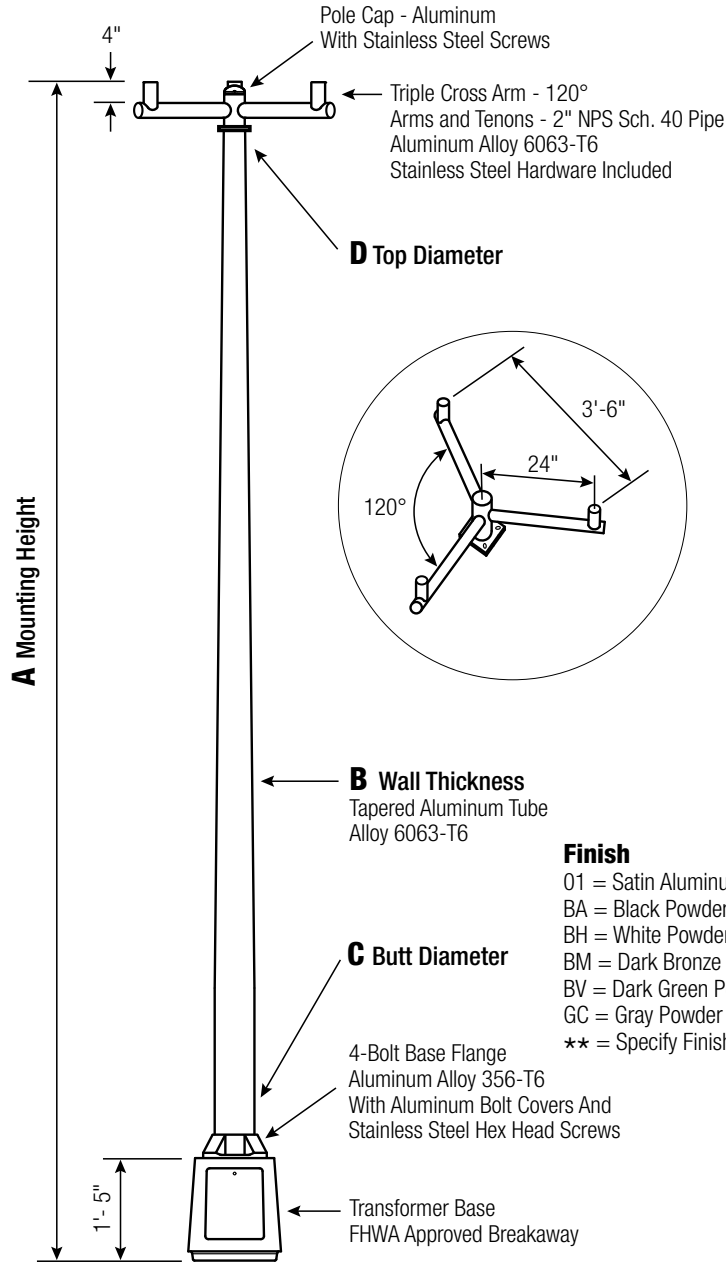

Finish

- O1 = Satin Aluminum
- BA = Black Powder Coat
- BH = White Powder Coat
- BM = Dark Bronze Powder Coat
- BV = Dark Green Powder Coat
- GC = Gray Powder Coat
- ** = Specify Finish

RTA25E8BFFFC0

CATALOG NUMBER

FINISH

Pole

The pole shaft will be constructed of seamless extruded tube of 6063 Aluminum Alloy per the requirements of ASTM B221. The shaft assembly shall be full-length heat treated after base weld to produce a T6 temper.

Base Style

Cast Aluminum Transformer Base (T-Base) of Alloy 356-T6 with Aluminum Door and Stainless Steel Hex Head Screw. FHWA Approved Breakaway.



Handhole

Tapered Door Opening (9-3/4" W Base x 9-1/4" W Top x 11-3/4" H) with Flush Mount Aluminum Cover and Stainless Steel Hex Head Screw. Grounding Provisions tapped 1/4"-20NC and 1/2"-13NC are provided.

Anchorage

Base Anchorage includes four (4) L-shaped Steel Anchor Bolts conforming to AASHTO M314-90 Grade 55, four (4) each Heavy-Duty Flat Washers, Lock Washers, and Hex Nuts (all components Galv. Steel). Ten inches (10") of threaded end will be galvanized per ASTM A153. **Top Connecting Hardware** includes four (4) each 1"-8NC x 3-3/4" Hex Head Bolts, Flat Washers, Heavy-Duty Flat Washers, Lock Washers, and Hex Nuts (all components Galv. Steel). A bolt circle template will be provided.

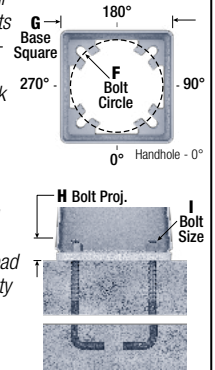

Vibration Damper

When determined necessary by Hapco, a Vibration Damper will be factory-installed inside the pole shaft. Customer specification of the damper is available.



WARNING:

Do not install light pole without luminaire.

Satin Aluminum or Powder Coated Finish per Customer Specification.

A Mtg. Hgt.	B WALL THICKNESS	C BUTT DIAMETER	LUM. WEIGHT	MAXIMUM EPA					CATALOG NUMBER
				90	100	110	120	130	
25	0.219"	8	60	7.6	5.8	5.2	4.2	3.4	RTA25E8BFFFC0-**

C BUTT DIA.	D TOP DIA.	F BOLT CIR. DIA.	G BASE SQ.	H BOLT PROJ.	I BOLT SIZE
8	4.5	15	15.375	3.5	1 x 36 x 4

Dimensions in Inches

CUSTOMER NAME:

PROJECT:

LOCATION:

NOTES:

QUANTITY:



26252 Hillman Highway
Abingdon, VA 24210
800.368.7171
www.hapco.com

EPA Notes: Effective Projected Area (EPA) in square feet. EPA's calculated using wind velocity (mph) indicated in accordance with 2009 AASHTO LTS-5 using a 25 year design life. Maximum EPA is based on the luminaire weight shown. Increased luminaire weight may reduce the maximum EPA. If weight is exceeded, or if other design life or code is required, please consult the factory.