

# SSS

## Square Straight Steel Pole No Arm — 4-Bolt Base

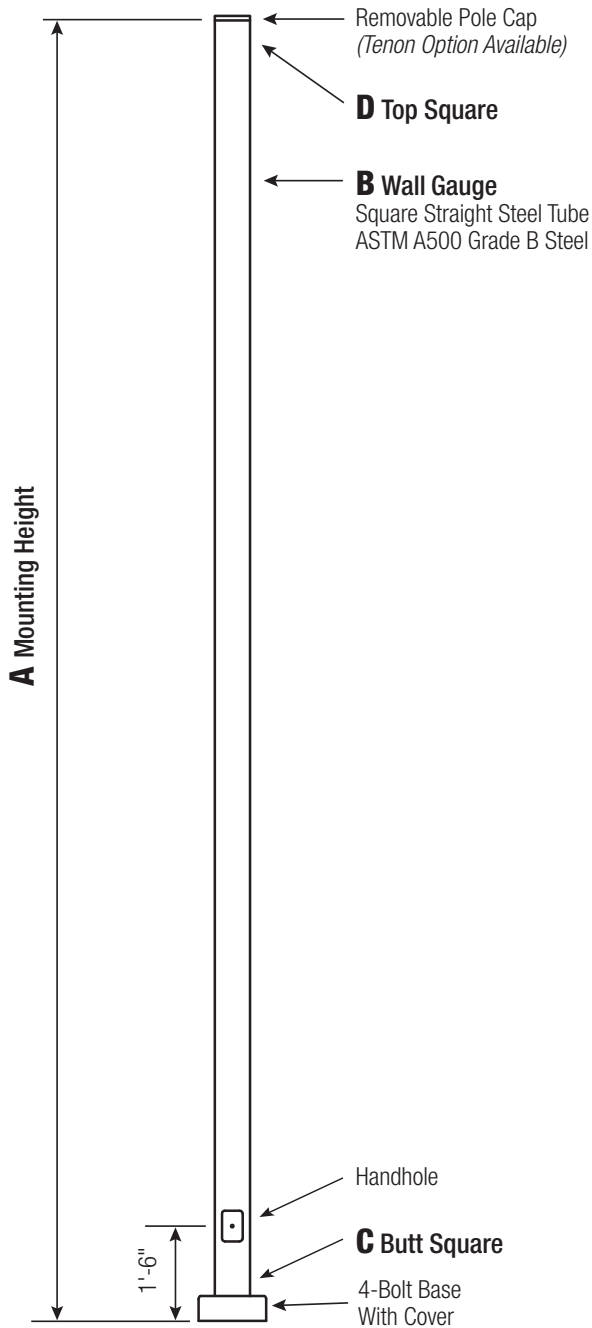

Powder Coated, Galvanized or Powder Coated over Galvanized Finish Per Customer Specification.

C BUTT SQ.	D TOP SQ.	F BOLT CIR. DIA.	G BASE SQ.	H BOLT PROJ.	I BOLT SIZE
4 (11 Gauge)	4	8 - 9	8	3.75	.75 x 17 x 3
4 (7 Gauge)	4	8 - 9	8	3.75	.75 x 30 x 3
5 (11 Gauge)*	5	10 - 12	11	3.75	.75 x 30 x 3
5 (7 Gauge)	5	10 - 12	11	4.875	1 x 36 x 4
6	6	11 - 13	12.5	4.875	1 x 36 x 4

\*Requires the use of oversized washers (provided).

Dimensions in Inches

### Pole

Pole shaft shall be weldable-grade, cold-rolled, commercial quality carbon steel tubing conforming to ASTM A500 Grade B. Options include 11 gauge and 7 gauge. All welds shall conform to AWS D1.1 using ER70S-6 electrodes.

### Base Style

4-Bolt Steel Plate Base Flange of fabricated hot rolled carbon steel conforming to ASTM A36 or equivalent (36 ksi minimum yield) with 2-piece Base Cover and attaching hardware.

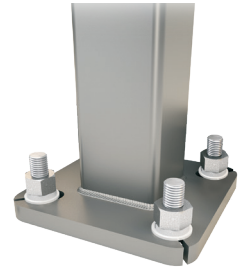

### Anchorage

Anchorage Kit will include four (4) L-shaped Steel Anchor Bolts conforming to AASHTO M314-90 Grade 55. Ten inches (10") of threaded end will be galvanized per ASTM A153.

Kits will contain eight (8) Hex Nuts, four (4) Lock Washers, and eight (8) Flat Washers (all components Galvanized Steel). A paper bolt circle template will be provided.

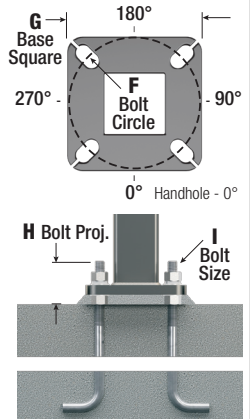

### Handhole

Reinforced, 3" x 5" Handhole with cover, stainless steel screw and backbar. A grounding provision incorporating a tapped 1/2"-13NC hole will be provided.



### Base Cover

Square ABS plastic Base Covers are standard on all SSS poles specified in BA-Black, BM-Dark Bronze and BH-White. SSS poles specified in all other colors will be manufactured of metal materials. Custom specification of SSS square metal style Base Covers in BA, BM and BH powder coated finishes is available.

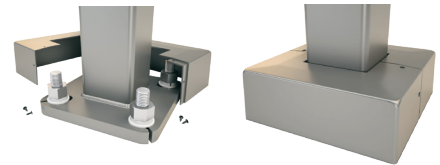

### Vibration Damper

If determined necessary by Hapco, or if specified by the customer, a first and/or second mode vibration damper will be provided.

A Mtg. Hgt.	B Wall Gauge	C Butt Sq.	TOTAL Lum. Weight	MAXIMUM EPA						CATALOG NUMBER
				90	100	110	120	130	140	
10	11	4	320	25.2	20.0	18.6	15.3	12.7	10.6	SSS10B4-4**
12	11	4	285	20.6	16.2	14.9	12.1	9.9	8.2	SSS12B4-4**
14	11	4	255	17.0	13.2	12.1	9.7	7.8	6.3	SSS14B4-4**
15	11	4	245	15.5	11.9	10.9	8.6	6.8	5.4	SSS15B4-4**
15	7	4	305	23.4	18.4	17.0	13.8	11.4	9.4	SSS15D4-4**
16	11	4	235	14.0	10.7	9.7	7.6	5.9	4.6	SSS16B4-4**
16	7	4	290	21.5	16.8	15.5	12.5	10.2	8.4	SSS16D4-4**
18	11	4	215	11.3	8.4	7.6	5.7	4.3	3.2	SSS18B4-4**
18	7	4	265	18.0	13.9	12.8	10.2	8.2	6.6	SSS18D4-4**
20	11	4	200	9.1	6.5	5.8	4.2	2.9	1.9	SSS20B4-4**
20	11	5	235	14.1	10.3	9.2	6.8	4.9	3.4	SSS20B5-4**
20	7	4	240	15.1	11.5	10.5	8.2	6.5	5.0	SSS20D4-4**
20	7	5	330	26.3	20.3	18.6	14.8	11.9	9.6	SSS20D5-4**
22	11	4	200	7.2	4.9	4.2	2.8	1.7	0.8	SSS22B4-4**
22	11	5	215	11.4	8.0	7.1	4.9	3.2	1.9	SSS22B5-4**
22	7	4	225	12.7	9.5	8.6	6.6	5.0	3.7	SSS22D4-4**
22	7	5	300	22.4	17.1	15.6	12.2	9.6	7.5	SSS22D5-4**
25	11	4	200	4.7	2.8	2.2	1.0	-	-	SSS25B4-4**
25	11	5	200	8.0	5.1	4.3	2.4	1.0	-	SSS25B5-4**
25	7	4	205	9.7	6.9	6.2	4.4	3.1	2.0	SSS25D4-4**
25	7	5	260	17.7	13.2	11.9	9.0	6.7	4.9	SSS25D5-4**
28	11	4	200	2.6	1.0	-	-	-	-	SSS28B4-4**
28	11	5	200	5.1	2.6	1.9	-	-	-	SSS28B5-4**
28	7	4	200	7.1	4.8	4.1	2.6	1.5	-	SSS28D4-4**
28	7	5	235	13.9	9.9	8.8	6.3	4.3	2.7	SSS28D5-4**
30	11	5	200	3.4	1.1	-	-	-	-	SSS30B5-4**
30	7	4	200	5.6	3.5	2.9	1.6	-	-	SSS30D4-4**
30	7	5	215	11.7	8.0	7.0	4.7	2.9	1.5	SSS30D5-4**
30	7	6	275	19.2	13.7	12.2	8.7	5.9	3.8	SSS30D6-4**
35	7	5	200	6.9	4.0	3.1	1.2	-	-	SSS35D5-4**
35	7	6	220	12.6	8.0	6.8	3.9	1.6	-	SSS35D6-4**
39	7	6	200	8.2	4.2	3.1	0.6	-	-	SSS39D6-4**

### Catalog Number System

The catalog number for Hapco poles utilizes the following identification system.

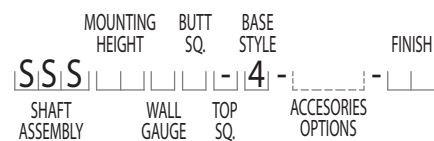

### Catalog Number Example -

**SSS 20 D 5 - 4 - BA**

Square Straight Steel, 20' Mounting Height, 7 Gauge, 5" Butt Square, No Taper, 4-Bolt Base, Black Powder Coat Finish.

### EPA Notes:

Effective Projected Area (EPA) in square feet. EPA's calculated using wind velocity (mph) indicated in accordance with 2009 AASHTO LTS-5 using a 25-year design life. Maximum EPA is based on the luminaire weight shown. Increased luminaire weight may reduce the maximum EPA. If weight is exceeded, or if other design life or code is required, please consult the factory.

### Mounting Options

#### Side Drill Mount

Includes removable pole cap.

NOTE: A luminaire drilling template must be supplied at time of order.



#### Tenon Mount

For Tenon Mount applications specify both Tenon diameter and length.



### Drill Mount Options

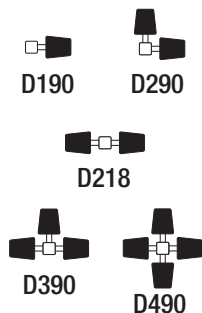

### Electrical Box

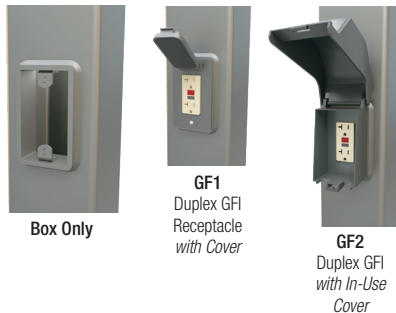

Note: GFI Options must be specified in Accessories.

### Pole Orientation

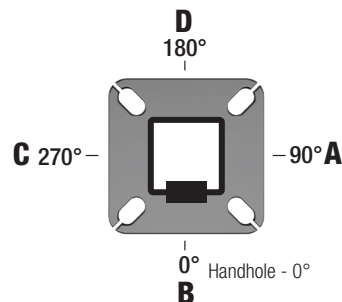

SSS- SQUARE STRAIGHT STEEL POLE	HEIGHT	GAUGE	BUTT Sq.	TOP Sq.	BASE STYLE	MOUNTING OPTIONS	ELECTRICAL BOX*	ACCESSORIES/OPTIONS*	FINISH
	10 = 10'	B =	4 = 4"	"-" =	4 =	<b>DRILL MOUNT</b>	FA - 30" Up, "D"	<b>C12</b> - Threaded 1/2" Coupling**	<b>POWDER COAT COLORS</b>
12 = 12'	11 Gauge	5 = 5"	No Taper	4-Bolt Base	D000 - No Drilling	FB - 30" Up, "B"	<b>C34</b> - Threaded 3/4" Coupling**	BA - Black Powder Coat	
14 = 14'	D = 7 Gauge	6 = 6"			D190 - Std. "A"	FC - 30" Up, "A"	<b>C10</b> - Threaded 1" Coupling**	BH - White Powder Coat	
16 = 16'		D290 - Std. "A" & "D"	FD - 30" Up, "C"	<b>EHH</b> - Extra Handhole**	BM - Dark Bronze Powder Coat				
18 = 18'		D218 - Std. "A" & "C"	FE - 36" Up, "D"	<b>GF1</b> - Duplex GFI Receptacle (WR) with Cover	BV - Dark Green Powder Coat				
20 = 20'		D390 - Std. "A", "D", & "C"	FF - 36" Up, "B"	<b>GF2</b> - Duplex GFI (WR) with In-Use Cover	GC - Gray Powder Coat				
22 = 22'		D490 - Std. "A", "B", "C", & "D"	FG - 36" Up, "A"	<b>LAB</b> - Less Anchor Bolts	GX - Special Colors*				
25 = 25'	DCUS - Custom*	FH - 36" Up, "C"	<b>LPC</b> - Less Pole Cap	<b>GALVANIZED</b>					
28 = 28'		FI - 24" Up, "D"	<b>PAB</b> - Pre-shipped Anchor Bolts	1Q - Galvanized Only					
30 = 30'		FL - 24" Up, "C"	<b>VD1</b> - Vib. Damper - 1st Mode	1C - Black PC Over Galv.					
35 = 35'		FZ - Custom**	<b>VD2</b> - Vib. Damper - 2nd Mode	1D - White PC Over Galv.					
39 = 39'				1B - D. Bronze PC Over Galv.					
				1Y - D. Green PC Over Galv.					
				1J - Gray PC Over Galv.					
				XX - Special PC Over Galv.*					

\* Specify Number and Orientation  
\*\* Specify O.D. and Height

\* GFI Receptacle Options Available (Specify in Accessories)  
\*\* Specify Height and Orientation

\* Add all that apply (Example: CPL-LAB-VD1)

\*\* Specify Location

\* Provide RAL # or Sample Color Chip