



# Hapco Solar Pole

SOLAR TODAY. BRIGHTER TOMORROW.™

## SLR4-FSA80

Quad Module Solar Pole

30' MH · 440Wp · 1250Wh · 80W LED Fixture



Superior Aesthetics



Advanced Solar Technology



Highest-Performing  
Lithium NMC Batteries



4G Connectivity



Year Round, Autonomous Lighting



Easy, Plug-and-Play Installation



Smart City Device Ready



Low Total Cost of Ownership



5-Year Remote Monitoring



Full 5-Year Warranty  
(No Pro-Rating)

**A COMPLETELY ENGINEERED  
SOLAR POLE SYSTEM**

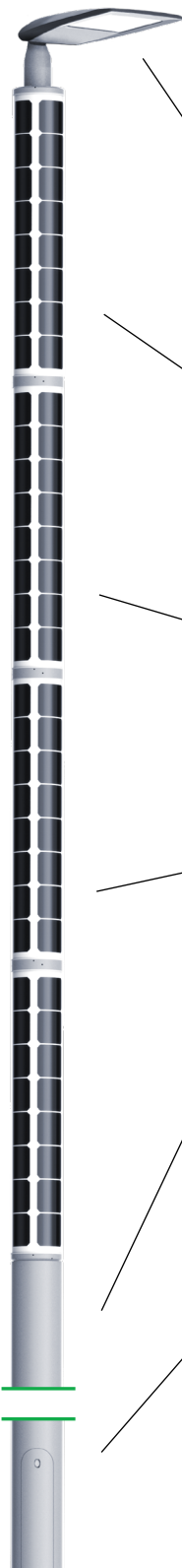

### LED Performance

Long life. High efficacy. Solar optimized remote driver.

### Monocrystalline Solar Panels

Unparalleled efficiency. Four (4) maximum power point trackers per module.

### Aerodynamic Design

Unmatched EPA and Wind Load ratings. Maintenance-free.

### Wireless Connectivity – Remote Monitoring

Track system parameters and historical data online. Automatic over-the-air software updates.

### Aluminum Pole

The strongest, most reliable light pole in the market featuring Proven Performance and a Lifetime Warranty.

### Solar Control Unit

The battery, driver, and controller are designed into a single unit, safely secured inside the pole at ground level.



<b>CUSTOMER NAME:</b>	
<b>PROJECT:</b>	<b>LOCATION:</b>
<b>NOTES:</b>	

## SLR4-FSA80 | Quad Module Solar Pole

30' MH · 440Wp · 1250Wh · 80W LED Fixture

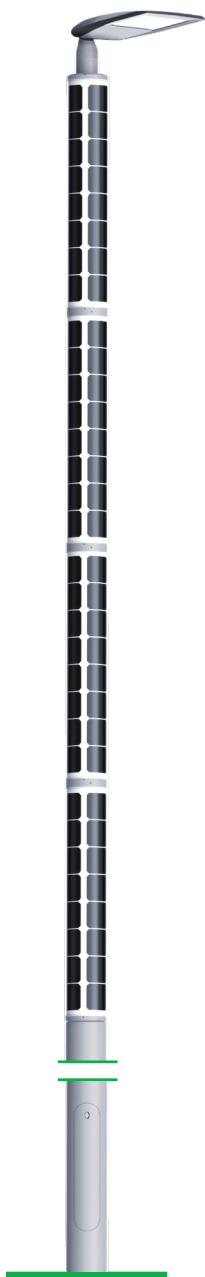

### Pole Specification

**Material:** 6063 Aluminum Alloy, Heat Treated After Weld  
**Mounting Height:** 30'  
**Shaft/Top Dia.:** 8"/4.5"  
**Wall Thickness:** .250"  
**Access Door:** Flush, Locking Handhole with Key  
**Anchorage Options:** Anchorage Base or Direct Buried  
**Fixture Mounting:** Tenon Mount

### Solar Module Specification

**Technology:** Monocrystalline Silicon Solar Cells  
**Cell Efficiency:** >24%  
**Module Dimensions:** 7.875" Dia. x 43.312" Tall  
**Service Life:** >25 Years  
**Backsheet Color Options:** White and Black  
**Number of Modules:** 4  
**Total Power:** ~440 Wp  
**Max. Power Point Tracking Channels:** 4 / Module  
**Weight:** ~15.5 lbs. / Module  
**Material:** Borosilicate Glass — IK-07 Impact Rating

### Battery Specifications

**Technology:** Lithium NMC  
**Capacity:** 1250 Wh  
**Service Life:** >10 Years  
**Location:** Inside Pole Shaft Opposite Access Door  
**Charge Efficiency:** 99.5%  
**Temperature Range:** -4°F to 140°F

### Control Electronics Specifications

**Mobile Comm.:** GSM/LTE-M  
**Encryption:** TLS 1.2  
**GNSS:** GPS, BeiDou, GALILEO, FLONASS, QZSS  
**Cable Update:** USB Programmable  
**Remote Update:** Yes  
**Remote Monitoring:** Yes  
**Time and Date:** Astronomical Clock  
**Service Life:** >10 Years

### Dimming

**Dynamic Dimming:** Algorithmically Optimized Light Output  
**Default (D1):** 100%/50%/100%

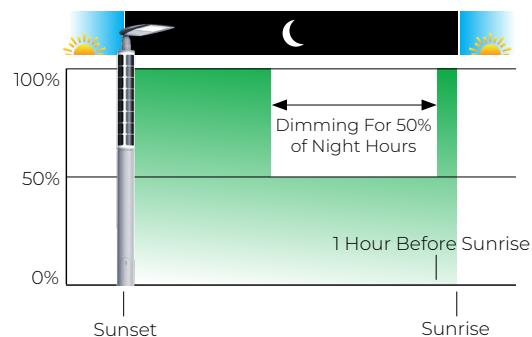

**Custom:** Fully Customizable Profiles Can Be Specified To Meet Building Efficiency Codes

### Fixture

**Style:** FSA80  
**Wattage:** 80W  
**LED Quantity:** 36  
**Dimensions:** 24.75" L x 13.06" W x 11.25" H  
**Material:** High Impact Diecast Aluminum (IK09)  
**CCT:** 4000K  
**Finish:** Black or Gray

### Warranty

**Warranties:** All Warranties Are 100% (Not Pro-Rated)  
**Battery:** 5 Years  
**Solar Components:** 5 Years  
**Fixture:** 5 Years  
**Pole:** Lifetime Warranty (Excluding Finish)

### Remote Monitoring

**Monitoring:** 5 Years

### Options

**Motion Sensor:** (MOT) Occupancy Awareness  
**Extended Monitoring:** (M10) 10 Years (From Std. 5)

SLR4 - [ ] - 1250 - 30 - F - [ ] - [ ] - FSA80 - 4K - [ ] - [ ] - [ ] - [ ]

HAPCO SOLAR POLE	MODULE COLOR	BATTERY	MOUNTING HEIGHT	WALL THICKNESS	ANCHORAGE	POLE FINISH	FIXTURE	CCT	DISTRIBUTION	DIMMING SCHEDULE	FIXTURE FINISH	OPTIONS
SLR4 = Quad Module	B = Black W = White	1250 = 1250WH	30 = 30'	F = 0.250"	4 = 4-Bolt Base E = Direct Buried	O1 = Satin BA = Black Powder Coat	FSA80	4K = 4000K	T1 T2 T3 T4 T5	D1 = Default DX = Custom* *Specify Schedule	BK = Black GR = Gray	MOT = Motion Sensor M10 = 10 Year Monitoring *Add all that apply. Ex. HYB-MOT-M10



# SLR4-FSA80

Quad Module Solar Pole

30' MH · 440Wp · 1250Wh · 80W LED Fixture

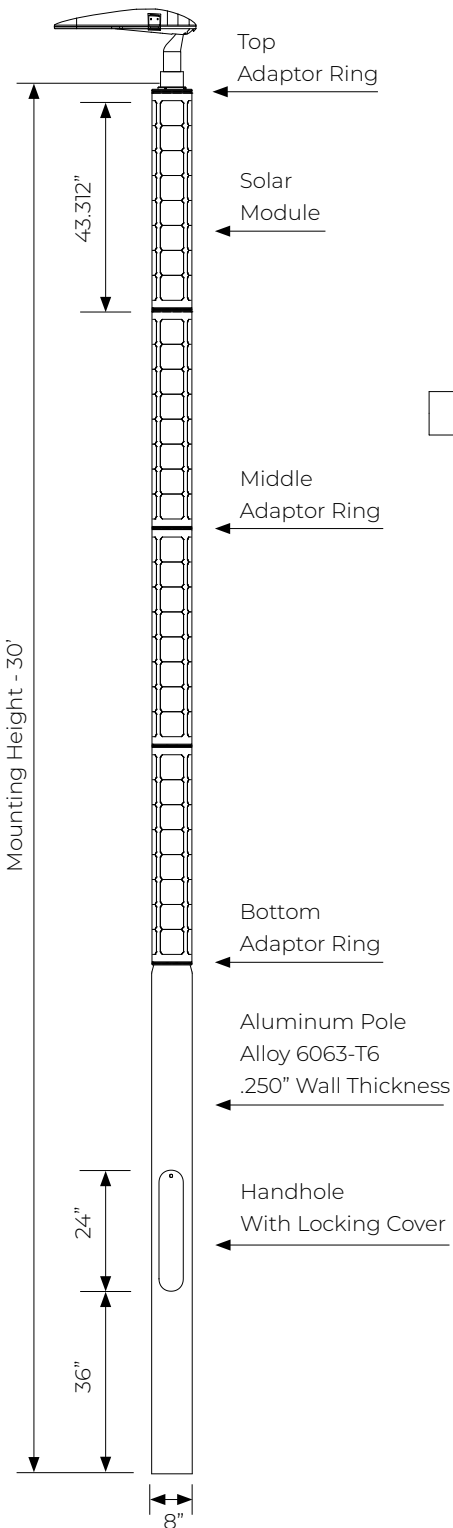

## FSA60 Fixture

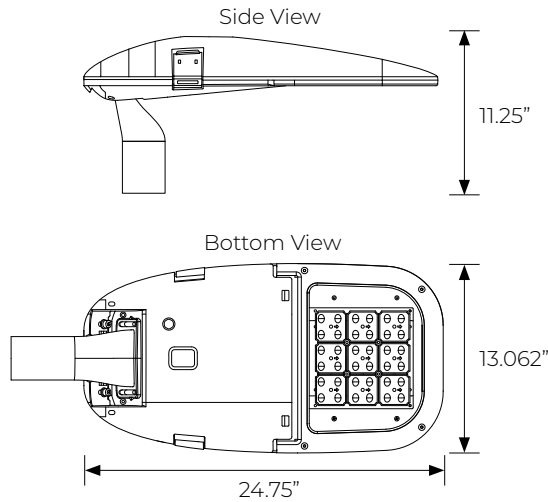

## Solar Control Unit

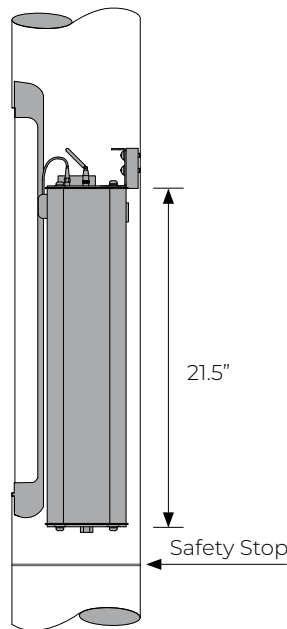

## Anchorage Options

### 4-Bolt Base

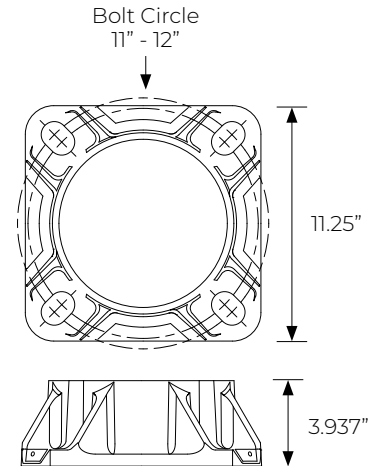

4-Bolt Cast Aluminum Base Flange of Alloy 356-T6 with Aluminum Bolt Covers (Alloy 356-F), Stainless Steel Hex Head Attaching Screws, and Four (4) 1" x 36" x 4" Steel Anchor Bolts Conforming to AASHTO M314-90.

### Direct Buried

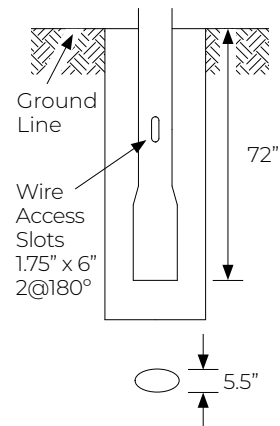

Direct Buried Pole bottom section will be partially flattened into an anti-rotational, oval cross section.



# Hapco Solar Pole

SOLAR TODAY. BRIGHTER TOMORROW.™



## FSA80

### 80W LED Luminaire

**HIGH EFFICIENCY. SUPERIOR PERFORMANCE. LONG LIFE.**

Hapco's FSA80 features a streamlined, modern style with a sleek and aerodynamic form factor specifically designed as a component of the Hapco Solar Pole. Its performance and aesthetics are optimized for solar powered operation. A remote DC driver as part of the Hand Hole Power Pack helps to reduce operating temperature and extend operating life while improving efficiency. Multiple lens options provide the light distribution flexibility needed for a plethora of pedestrian scale applications. Built-in lighting control helps meet code requirements and solar performance.

- Modern styling blends aesthetically with the Hapco Solar Pole, making it an ideal choice for a myriad of project applications.
- Solar optimized performance.
- Modular optical lens designs.
- Clearly labeled plug and play cables for ease of installation.
- Temperature management for extended life.
- Integrated wireless controls with dynamic dimming.



IP66

IK09

RoHS



#### Applications:

Streetscapes Walkways Pathways Parks & Rec  
Residential Streets Commercial Centers Campuses

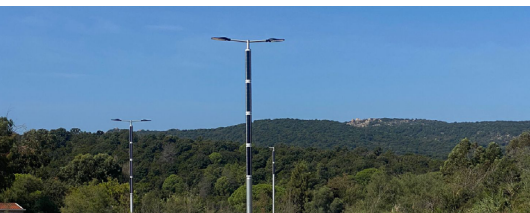



# Hapco Solar Pole

SOLAR TODAY. BRIGHTER TOMORROW.™



## FSA80

80W LED Luminaire

### Specifications

- EPA:** 1.9 ft<sup>2</sup>
- Dimensions:** 24.75" L x 13.06" W x 11.25" H
- Weight:** 20 lbs
- Material:** High Impact Diecast Aluminum (IK09)
- Mounting:** Fits Standard 2-3/8" Diameter OD Tenons

### Electrical

- LED Quantity:** 36
- Power:** 80W
- Max THD:** 20%
- Power Factor:** 0.90
- RoHS:** Compliant

### Control Options

- Lighting Scheme:** Automatic Adaption to Sunrise/Sunset
- Standard Dimming:** 100%/50%/100% (Sunset 100% - Dimming for 50% of Night Hours - 1 Hour Prior to Sunset 100%)
- Custom Dimming:** Match Any Project Specification
- Motion Sensor:** Optional

### Light Module

- CCT:** 4000K
- CRI:** >70
- Operating Temperature:** -30°F - 122°F
- LED Lifetime:** >70,000 Hours
- Protection Grade:** IP66

### Warranty

- Warranty:** 5-Year Limited Warranty

### PHOTOMETRICS

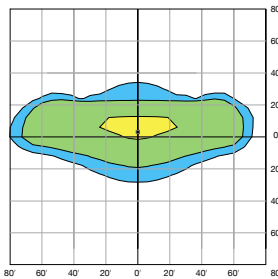

**Type I**  
12201 Lumens

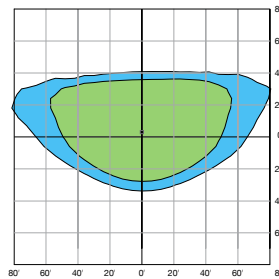

**Type II**  
11952 Lumens

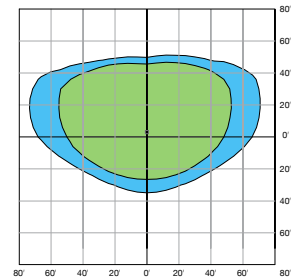

**Type III**  
12201 Lumens

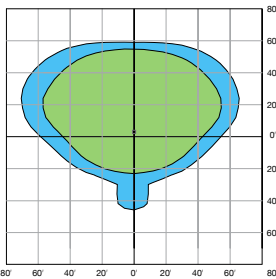

**Type IV**  
12201 Lumens

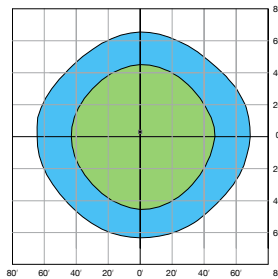

**Type V**  
11989 Lumens

- = 4 Foot Candles
- = 0.5 Foot Candles
- = 0.25 Foot Candles

Mounted at 30' AFG  
LLF = 0.90

# **SOLAR TODAY. BRIGHTER TOMORROW.™**



26252 Hillman Highway  
Abingdon, VA 24210