

RTA

Round Tapered Aluminum Pole with Arms Triple Cross Arm 120° — 4-Bolt Base

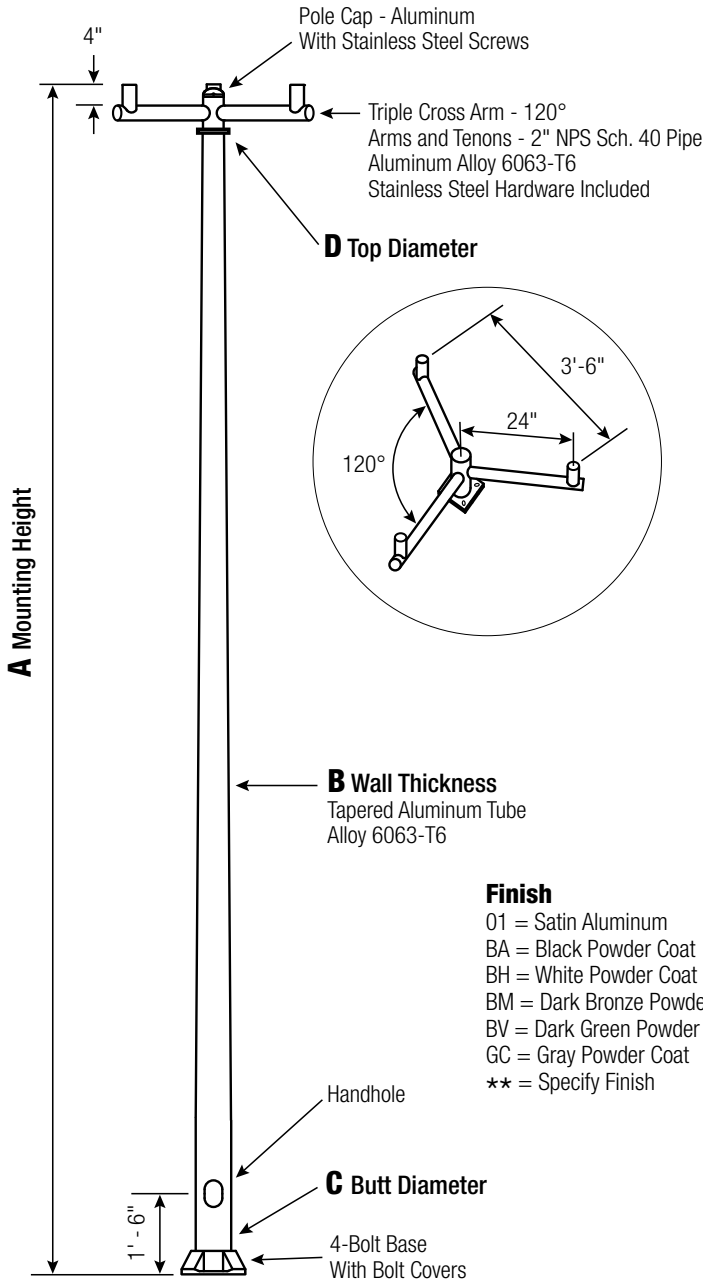

Finish

- O1 = Satin Aluminum
- BA = Black Powder Coat
- BH = White Powder Coat
- BM = Dark Bronze Powder Coat
- BV = Dark Green Powder Coat
- GC = Gray Powder Coat
- ** = Specify Finish

RTA25C7B4FC0

CATALOG NUMBER

FINISH

Pole

Shaft and arm will be constructed of seamless extruded tube of 6063 Aluminum Alloy per the requirements of ASTM B221. The shaft assembly shall be full-length heat treated after base weld to produce a T6 temper.

Base Style

4-Bolt Cast Aluminum Base Flange of Alloy 356-T6 with Aluminum Bolt Covers (Alloy 356-F) and Stainless Steel Hex Head Attaching Screws.



Handhole

Reinforced, 4" x 6" curved Cast Aluminum Frame (Alloy 356-T6) with Aluminum Door and two (2) SS Hex Head Screws. Reinforced Frame will contain a tapped 3/8" - 16NC Grounding Provision.

Anchorage

Anchorage Kit will include four (4) L-shaped Steel Anchor Bolts conforming to AASHTO M314-90 Grade 55. Ten inches (10") of threaded end will be galvanized per ASTM A153. Kits will contain four (4) Hex Nuts, four (4) Lock Washers, and four (4) Flat Washers (all components Galvanized Steel). A bolt circle template will be provided.

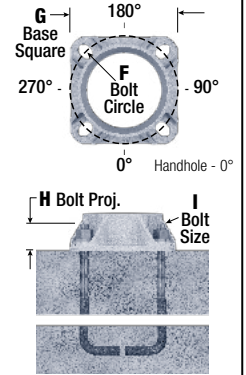

Vibration Damper

When determined necessary by Hapco, a Vibration Damper will be factory-installed inside the pole shaft. Customer specification of the damper is available.



WARNING:
Do not install light pole without luminaire.

Satin Aluminum or Powder Coated Finish per Customer Specification.

A Mtg. Hgt.	B Wall Thickness	C Butt Diameter	TOTAL LUM. WEIGHT	MAXIMUM EPA					CATALOG NUMBER
				90	100	110	120	130	
25	0.156"	7	25	3.0	2.0	1.8	1.2	-	RTA25C7B4FC0-**

C BUTT DIA.	D TOP DIA.	F BOLT CIR. DIA.	G BASE SQ.	H BOLT PROJ.	I BOLT SIZE
7	4.5	10 - 11	10.5	2.75	1 x 36 x 4

Dimensions in Inches

CUSTOMER NAME:	
PROJECT:	LOCATION:
NOTES:	QUANTITY:



26252 Hillman Highway
Abingdon, VA 24210
800.368.7171
www.hapco.com

EPA Notes: Effective Projected Area (EPA) in square feet. EPA's calculated using wind velocity (mph) indicated in accordance with 2009 AASHTO LTS-5 using a 25 year design life. Maximum EPA is based on the luminaire weight shown. Increased luminaire weight may reduce the maximum EPA. If weight is exceeded, or if other design life or code is required, please consult the factory.