

LIGHT POLES

Florida Building Code Guide



2017 FBC EPA's



*Advanced, State-Of-The-Art Manufacturing
Combined With Exceptional Engineering
and Design!*

A 60+ year history of providing quality pole products to Lighting Professionals worldwide.



With an industry-recognized reputation for excellence in Engineering, Research and Development, and Manufacturing, Hapco is proud of our long history of producing the highest quality products for the Commercial, Utility, Municipality, and DOT lighting markets.



Table of Contents

| | |
|---|-------|
| Wind Velocity Selection | 3 |
| Advantages of Aluminum Poles | 4 |
| Lifetime Pole Assembly Warranty | 5 |
| Catalog Part Number Description | 6 |
| Finishes | 7 |
| RTA Poles - 4-Bolt Base | 8-9 |
| RTA Poles - 3-Bolt Base | 10-11 |
| RTA Poles - Direct Buried. | 12-13 |
| RTA Poles - Hinged Base | 14-15 |
| RSA Poles - 4-Bolt Base | 16-17 |
| RSA Poles - 3-Bolt Base | 18-19 |
| RSA Poles - Direct Buried | 20-21 |
| RSA Poles - Hinged Base. | 22-23 |
| SSA Poles - 4-Bolt Base | 24-25 |
| SSA Poles - Direct Buried | 26-27 |
| SSS Poles - 4-Bolt Base | 28-29 |
| Proven Performance | 30 |
| Hapco Aluminum - The Green Choice | 31 |

www.hapco.com



For Hapco Terms and Conditions of Sale, visit <http://www.Hapco.com/resources/terms-and-conditions/>

This Hapco Florida Building Code Guide has been developed to provide a quick reference for EPAs (Effective Projected Areas) meeting the 2017 FBC.

The EPA's in this publication are based on the 3-second gust wind map taken from the 2017 Florida Building Code (Figure 1609A Wind Map shown below). These EPA's cannot be used with older or newer maps.

This Wind Map is to be used in conjunction with ASCE 7-16 Wind Pressure and 2009 AASHTO Design Equations. Wind regions from maps other than the one shown below may not represent the EPA values listed in this catalog. Please contact Hapco for more detailed information about EPA equations.

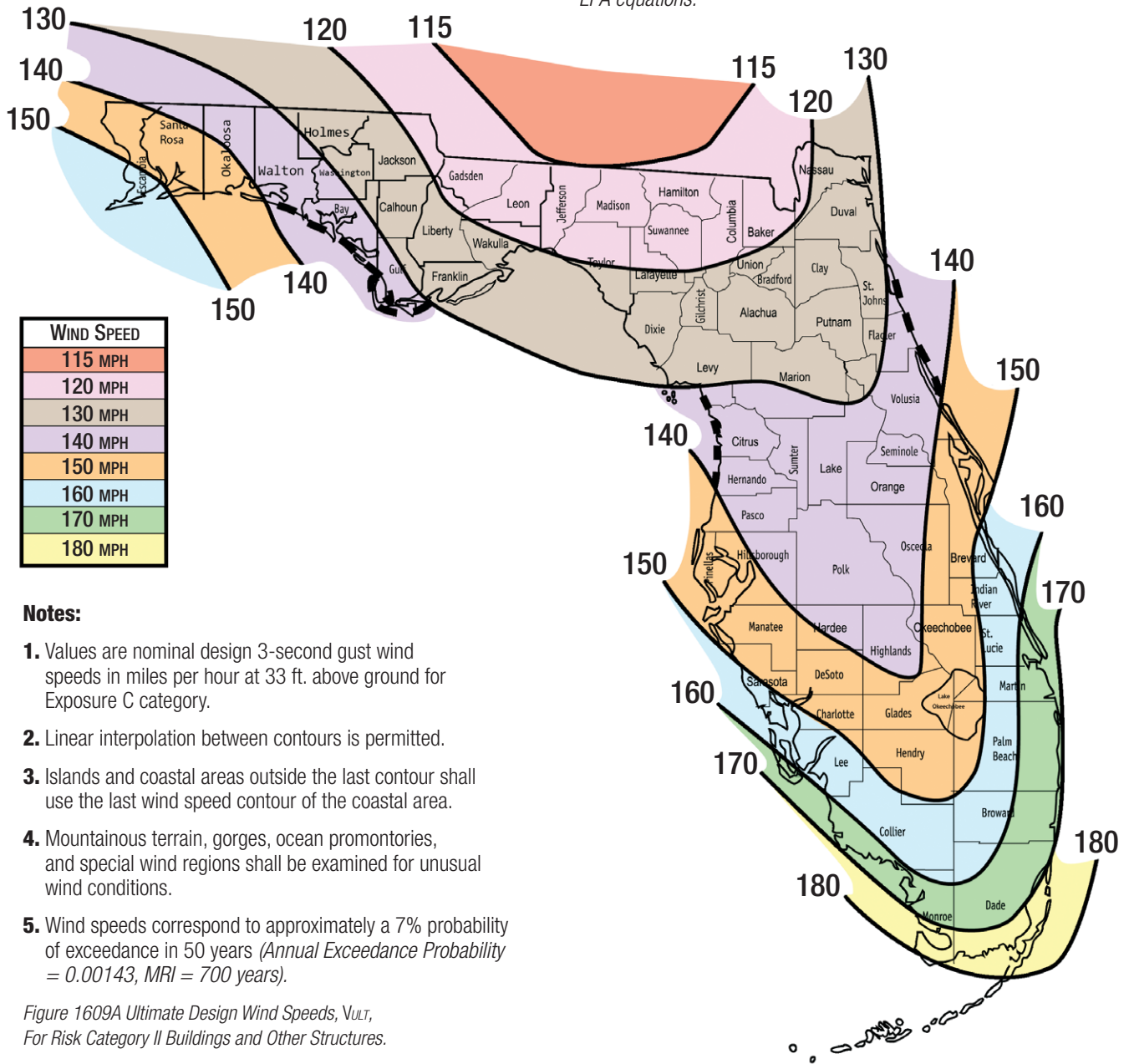

Shielding Factor

The table shown at right will assist you in calculating the total EPA for many of the popular luminaire configurations. Using the shielding factor to calculate total EPA prevents an over-designed pole being used, resulting in cost savings.

| LUMINAIRE CONFIGURATION | EPA | SHIELDING FACTOR | TOTAL EPA |
|-------------------------|-----|------------------|-------------------|
| 2 @ 180° | 1.5 | X 2.0 | = 3.0 |
| 3 @ 180° | 1.5 | X 3.0 | = 4.5 |
| 4 @ 180° | 1.5 | X 4.0 | = 6.0 |
| 3 @ 120° | 1.5 | X 2.3 | = 3.45 (Shielded) |
| 4 @ 90° | 1.5 | X 3.2 | = 4.8 (Shielded) |

Example assumes a single luminaire EPA of 1.5.

ASCE 7-16 Wind Load Design Assumptions:

- Risk Cat. II, MRI = 700 yrs., Exp. and Surface Roughness Cat. "C"
- $K_{zt} = 1.0$, $K_d = 1.0$, $G = 1.14$, $V_{ASD} = \sqrt{0.6} V_{ULT}$ (FBC 2017 1609.3.1)
- C_f = drag coefficients calculated per AASHTO LTS-6 (ASCE 7-16 C29.4)
- Strength Equations per AASHTO LTS-6 Allowable Stress Increase = 1.33

FLORIDA BUILDING CODE GUIDE
2017 FBC EPA's

Advantages of Aluminum Poles

Why Aluminum?

The superior properties of aluminum make it both the perfect choice and best value for outdoor lighting poles and brackets.

Corrosion Resistant

On contact with air, aluminum forms a protective layer of aluminum oxide that guards against corrosion. This natural resistance to corrosion ensures that your aluminum lighting pole will resist the ravages of time, temperature and humidity while providing years of low maintenance care.

Lightweight

Aluminum provides the perfect combination of lightweight material with high strength-to-weight ratios. At one-third the weight of steel, aluminum poles are much easier to handle and install, providing substantial installation savings in both labor and equipment.

Proven Performance

Hapco has been manufacturing quality Aluminum Pole Products for more than 60 years, with many of the original installations still in service with no structural issues or noticeable differences in appearance. The longevity and durability of our products can be validated with our industry-leading **Lifetime Warranty** on aluminum pole assemblies (see Page 5).

Lower Overall Cost of Ownership

The properties of aluminum make it a tremendous value when the overall cost of ownership is considered. Higher installation and maintenance costs for aluminum alternatives, combined with guaranteed replacement costs of shorter lifecycle materials, contribute to aluminum having the lowest cost of ownership of any lighting pole option.

The "Green" Choice

Aluminum provides an environmentally responsible choice of material and approach within the burgeoning green movement. Aluminum is the most abundant mineral in the earth's crust, reduces material replacement energy by its incredibly long life cycle, and is 100% recyclable.



Aluminum



Steel

Composite

Concrete

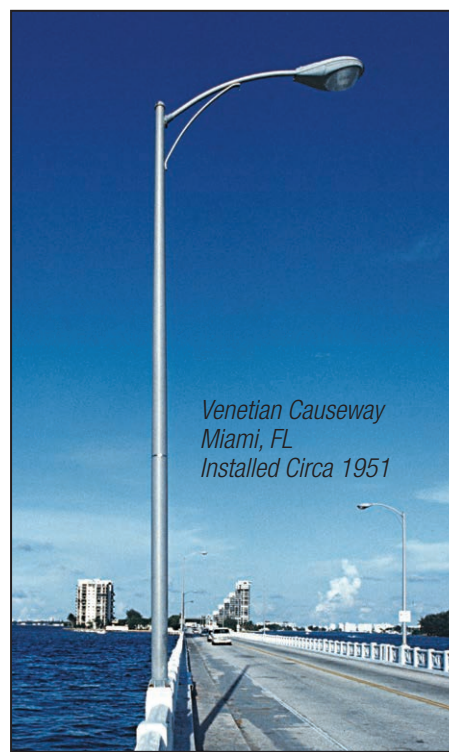

Venetian Causeway
Miami, FL
Installed Circa 1951



The Aluminum Advantage

When compared to alternative materials, the advantages of aluminum are substantial.

Steel

- Steel is not corrosion resistant and will begin to deteriorate as soon as it is installed, allowing visible rust and corrosion which lead to higher maintenance costs.
- Inherently shorter lifecycles contribute to an overall higher cost of ownership when compared to aluminum.
- Weighs three times as much as aluminum.
- Limited recycle value.
- Should not be Direct Buried.

Composite

- Composite poles are affected by ultraviolet fading and fiber blooming, quickly leading to poor aesthetics in many environments.
- Can be damaged by mowing or trimming. Round aluminum poles are heat treated after base weld to a full T6 temper, giving superior resistance to cuts and abrasions from trimmer and mowers.
- No recycle value, making them difficult and expensive to dispose of in case of pole knockdowns.
- Expensive maintenance costs associated with repainting and replacement.
- Excessive deflection of the top of poles with many arm/luminaire combinations.
- Limited breakaway designs.

Concrete

- Concrete is much heavier than Aluminum, resulting in significantly higher shipping and labor costs.
- Product Weight Comparison -
25' Mounting Height
Aluminum pole = 140 lbs.
Concrete Pole = 1100 lbs.
- Slower, less efficient installations translate into extended job completion times.
- Difficult to install, requiring expensive installation equipment and larger installation crews.
- No breakaway performance, making concrete more hazardous in regards to highway safety than other pole materials.
- Susceptible to spalling (crumbling), staining and fading.
- No recycle value.

Lifetime Aluminum Pole Assembly Warranty

Lifetime Quality...Guaranteed

At Hapco, it is our mission to create lasting customer relationships by providing the very best quality products. We do this by combining the most advanced, industry-leading manufacturing technologies with exceptional engineering and design.

Because we stand behind our products and truly believe in their longevity and durability, our aluminum pole assemblies are covered by a Lifetime Warranty.



“As a leader in the manufacture of aluminum lighting poles for more than 60 years, we are proud to be the first in the metal pole industry to offer this guarantee. We have the facilities, the products, the people, the experience and the desire to become and stay your FIRST choice for aluminum pole solutions.”

Lifetime Warranty

Hapco warrants its aluminum pole assemblies for their lifetime to be free of defects in material and workmanship and to be free from corrosion, except those items normally consumed in service. This warranty does not cover failures or corrosion due to:

- Improper installation.
- Misapplication – product used outside of specified use.
- Damage from handling, transportation, installation, vehicular impact, abuse, or vandalism.
- Site specific wind induced or other vibration.
- Installation in soils with a pH under 5 or over 9.
- Improper grounding.

Hapco will, at its sole option, repair, replace, or credit Buyer's account for any product that does not conform to this warranty.

HAPCO MAKES NO OTHER WARRANTIES, EXPRESS OR IMPLIED, INCLUDING THE IMPLIED WARRANTIES OF MERCHANTABILITY OR FITNESS FOR A PARTICULAR PURPOSE. HAPCO SHALL NOT BE LIABLE FOR ANY OTHER LOSS OR DAMAGE, INCLUDING BUT NOT LIMITED TO CONSEQUENTIAL DAMAGES, LIQUIDATED DAMAGES AND BACK CHARGES.

This warranty does not include reimbursement for the expense of installation or removal of equipment, transportation, or any other expenses which may be incurred. This warranty applies to the pole assembly only and does not include anchor bolts, connecting hardware, or foundation. Authorization must be obtained from Hapco before any material is returned. This warranty excludes finishes such as powder coating, anodizing, and satin. "Lifetime" is defined as the lifetime of the products intended use. The foregoing states the Buyer's sole remedy for any breach of warranty by Hapco.

This warranty applies only to Hapco aluminum pole assemblies shipped on or after January 1st, 2011.

Hapco
26252 Hillman Highway
Abingdon, VA 24210
800.368.7171
www.hapco.com

Catalog Part Number Description

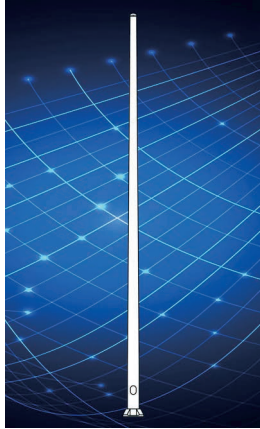

Aluminum Catalog Part Number -
No Arm

A General Shaft Assembly

RSA = Round Straight Aluminum
RTA = Round Tapered Aluminum
SSA = Square Straight Aluminum

B Mounting Heights

| | | |
|----------|----------|----------|
| 08 = 8' | 16 = 16' | 35 = 35' |
| 10 = 10' | 18 = 18' | 40 = 40' |
| 12 = 12' | 20 = 20' | 45 = 45' |
| 14 = 14' | 25 = 25' | 50 = 50' |
| | 30 = 30' | |

C Wall Thickness

| | |
|------------|------------|
| B = 0.125" | F = 0.250" |
| C = 0.156" | G = 0.312" |
| D = 0.188" | H = 0.375" |
| E = 0.219" | |

D Butt Diameter

| | | |
|---------|------------|--------|
| 1 = 10" | 5 = 5" | 7 = 7" |
| 2 = 12" | 6 = 6" | 8 = 8" |
| 4 = 4" | J = 6.625" | 9 = 9" |

E Top Diameter

| | |
|----------|---------------|
| A = 3" | C = 6" |
| B = 4.5" | -- = No Taper |

F Base Style

3 = 3-Bolt Anchor Base
4 = 4-Bolt Anchor Base
V = Bee Hive Base
H = Hinged Anchor Base
D = FBC Direct Buried (*Embed*)
F = Breakaway Transformer Base

G Finish

01 = Satin Aluminum (*RTA and RSA*)
BA = Black Powder Coat
BH = White Powder Coat
BM = Dark Bronze Powder Coat
BV = Dark Green Powder Coat
GC = Gray Powder Coat
** = Specify Finish

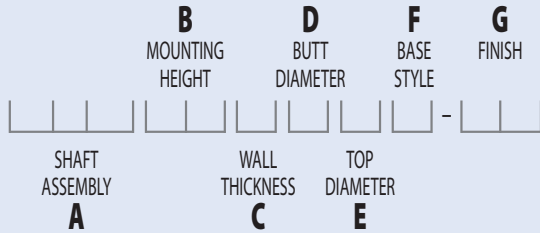

Example:

RTA30D8B4-01

*Round Tapered Aluminum, 30'
Mounting Height, .188" Wall
Thickness, 8" Butt Diameter,
4.5" Top Diameter,
4-Bolt Base,
Satin Aluminum Finish*



Steel Catalog Part Number -
No Arm

A General Shaft Assembly

SSS = Square Straight Steel

B Mounting Heights

| | | |
|----------|----------|----------|
| 10 = 10' | 16 = 16' | 25 = 25' |
| 12 = 12' | 18 = 18' | 30 = 30' |
| 14 = 14' | 20 = 20' | 35 = 35' |

C Wall Thickness

B = 11 Gauge
D = 7 Gauge

D Butt Square

| | | |
|--------|--------|--------|
| 4 = 4" | 5 = 5" | 6 = 6" |
|--------|--------|--------|

E Top Square

-- = No Taper

F Base Style

4 = 4-Bolt Anchor Base

G Finish

BA = Black Powder Coat
BH = White Powder Coat
BM = Dark Bronze Powder Coat
BV = Dark Green Powder Coat
GC = Gray Powder Coat
** = Specify Finish
00 = Galvanized Only (*No Powder Coat*)

K Galvanization

G = Galvanized

Code "G" to be used only if
pole is to be Galvanized

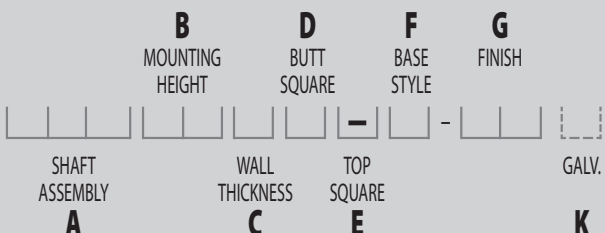

Example:

SSS20B4-4-BM

*Square Straight Steel,
20' Mounting Height,
11 Gauge Wall Thickness,
4" Butt Diameter,
Dark Bronze
Powder Coat Finish*

Satin Aluminum Finish

Hapco's Satin Aluminum is a polished aluminum finish achieved in a multi-pass, mechanical rotary sanding operation. No alternative finish option offers a lower overall cost of ownership or longer aesthetic beauty, making it the industry's first choice for low-maintenance and enduring finishes.



01 – Satin Aluminum Finish – Round Poles

Hapco's RTA and RSA round aluminum poles are constructed of Aluminum Alloy 6063. This marine grade alloy is composed primarily of Aluminum, Magnesium and Silicone and is chosen because of its superior attributes and extremely high resistance to corrosion. On contact with air, these aluminum alloys naturally oxidize, creating a layer of aluminum oxide on the surface of the pole that effectively and permanently guards against corrosion.

Thermoset Powder Coat Finishes

Hapco's on-site, state-of-the-art powder coating operations utilize weather resistant triglycidyl isocyanurate (TGIC) polyester thermoset powders that are electrostatically applied, oven cured and bonded to a minimum dry film thickness of 2.0 mils. The National Association of Architectural Metal Manufacturers, *Metal Finishes Manual*, rate the outdoor life of these powders at 15 plus years.

AAMA 2604

All polyester thermoset powders are not created equal. The American Architectural Manufacturers Association (AAMA) provides classifications for powder coatings which are industry recognized standards for testing and performance. AAMA 2604 coatings, known as Super Durable, are formulated with advanced polyester resin technology that utilizes higher performance pigments. Qualities include superior gloss, color retention and weathering capabilities, better exterior durability and UV resistance, and highly resistant scratching, chipping and peeling characteristics.

AAMA specifications for the testing and evaluation of coatings use a South Florida (27° Latitude) benchmark due to its extreme weather conditions. Testing categories for AAMA 2604 acceptance include a 5-year 45° Sun Exposure, 3000 Hour Humidity Resistance, and 3000 Hour Salt Spray. AAMA 2604 powders are rated to withstand outdoor exposure for five (5) years in this worst case environment. In comparison, some competitors use AAMA 2603 coatings. AAMA 2603 products are rated for only one (1) year.

Hapco only uses AAMA 2604 powders, assuring project owners the longest lasting, lowest maintenance powder painted products available in the market today.

Hapco's use of AAMA 2604 Powders Reduces Overall Ownership Cost By Providing Longer Lasting Aesthetics.

Standard Colors

Hapco standard powder coat colors are provided in a textured design for improved mar resistance.

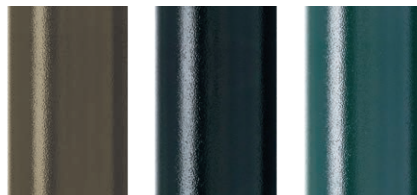

Dark Bronze
BM

Black
BA

Dark Green
BV



Gray
GC

White
BH

RAL and Custom Colors

Along with our standard colors, Hapco can provide both RAL and custom colors. Options are unlimited. Simply provide any RAL Color Number or Color Chip Sample and Hapco will provide the perfect AAMA 2604 Powder Paint Color for your next project.



RAL Colors

Powder Coat 5-Year Finish Warranty

Hapco warrants its factory-applied powder coatings against cracking, peeling or excessive fading due to normal climatic exposure for a period of five (5) years from the date of shipment. Damage to the finish coating caused by mechanical abuse, such as rough handling during installation or by vandalism, is not covered by this warranty. This warranty is limited to, at the seller's option, the repair or replacement of the material involved and shall not include reimbursement of consequential expenses such as installation, removal of equipment, or transportation costs.

Anodized Finish

Aluminum pole anodized colors are limited to clear, black and various shades of bronze.

Color Uniformity

While a color finish on aluminum poles can be obtained by either anodizing or powder painting, anodizing of pole assemblies will inherently result in color variations and color uniformity is not guaranteed. Variations in the physical or chemical composition of the metals contained in the base flange, pole shaft, welds, and pole accessories create color variations in anodized finishes that are unavoidable. Color variations in anodized finishes are not covered under Hapco warranty.

Powder Coat finishes offer a more attractive price and lead time compared to anodized products and are recommended for guaranteed uniformity of color.

Galvanized Finish

In addition to our standard Powder Paint finish, Hapco Steel poles are offered in both Galvanized and Powder Paint over Galvanized options. All galvanized steel poles are hot dip galvanized to meet ASTM-A-123 specifications.

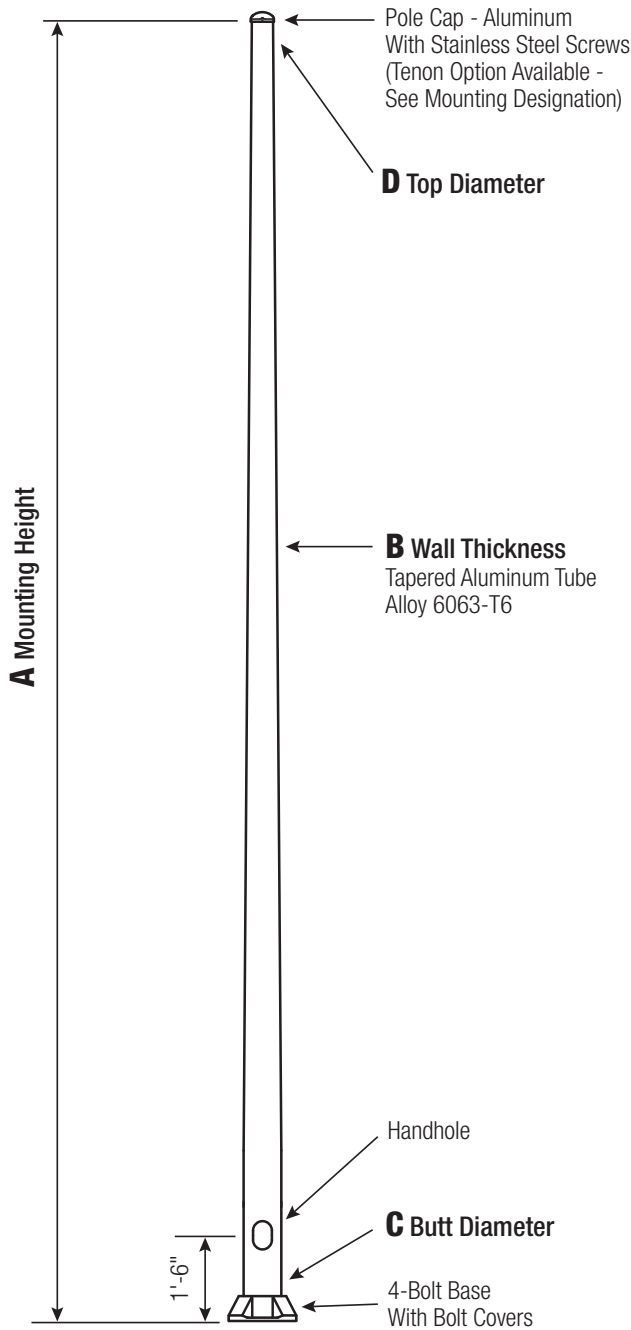

Satin Aluminum or Powder Coated Finish per Customer Specification.

| C BUTT DIA. | D TOP DIA. | F BOLT CIR. DIA. | G BASE SQ. | H BOLT PROJ. | I BOLT SIZE |
|-----------------------|----------------------|----------------------------|----------------------|------------------------|-----------------------|
| 4 | 3 | 6.5 - 8 | 7.5 | 2 | .75 x 17 x 3 |
| 5 | 3 | 7.5 - 8 | 7.5 | 2 | .75 x 17 x 3 |
| 6 | 4.5 | 9 - 10 | 9.75 | 2.75 | .75 x 30 x 3* |
| 7 | 4.5 | 10 - 11 | 10.5 | 2.75 | 1 x 36 x 4 |
| 8 | 4.5 | 11 - 12 | 11.25 | 2.75 | 1 x 36 x 4 |
| 9 | 4.5 | 12.5 - 14 | 12.75 | 2.75 | 1 x 36 x 4 |
| 10 Up To .250" | 6 | 14 - 15 | 14 | 3.25 | 1 x 48 x 4 |
| 10 .312" | 6 | 14 - 15 | 14 | 3.25 | 1.25 x 48 x 6 |

*1" x 36" x 4" Anchor Bolts can be specified for 6" butt diameter poles.

Dimensions in Inches

Pole

The pole shaft will be constructed of seamless extruded tube of 6063 Aluminum Alloy per the requirements of ASTM B221. The shaft assembly shall be full-length heat treated after base weld to produce a T6 temper.

Base Style

4-Bolt Cast Aluminum Base Flange of Alloy 356-T6 with Aluminum Bolt Covers (Alloy 356-F) and Stainless Steel Hex Head Attaching Screws.



Handhole

4"-5" Butt Diameters - 2" x 4" Handhole with curved Lap Style Aluminum Door and two (2) SS Self-Tapping Attaching Screws. A Grounding Provision incorporating a tapped 1/4"-20NC hole is provided.

6" Butt Diameter - Reinforced, 3" x 5" curved Cast Aluminum Frame (Alloy 356-T6) with Aluminum Door and two (2) SS Hex Head Screws. A Grounding Provision incorporating a 3/8" diameter hole is provided opposite the Handhole.

7"+ Butt Diameters - Reinforced, 4" x 6" curved Cast Aluminum Frame (Alloy 356-T6) with Aluminum Door and two (2) SS Hex Head Screws. Reinforced Frame will contain a tapped 3/8"-16NC Grounding Provision.

Anchorage

Anchorage Kit will include four (4) L-shaped Steel Anchor Bolts conforming to AASHTO M314-90 Grade 55. Ten inches (10") of threaded end will be galvanized per ASTM A153.

Kits will contain four (4) Hex Nuts, four (4) Lock Washers, and four (4) Flat Washers (all components Galvanized Steel). A bolt circle template will be provided.

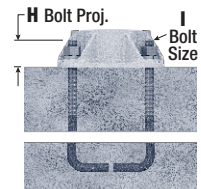
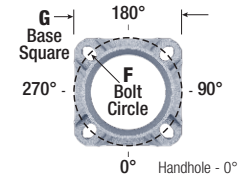

Vibration Damper

When determined necessary by Hapco, a Vibration Damper will be factory-installed inside the pole shaft. Customer specification of the damper is available.

Mounting Designation

Side Drill Mount

For Side Drill Mount applications specify luminaire type, quantity and orientation. A luminaire drilling template must be supplied at time of order.

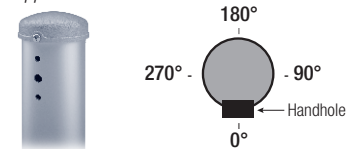

Tenon Mount - Welded or Spun

For Tenon Mount applications specify both Tenon diameter (2.375", 2.875", 3.5", etc.) and length (3", 4", etc.). Tenon style is factory option. Welded Tenon can be specified.



WARNING: Do not install light pole without luminaire.

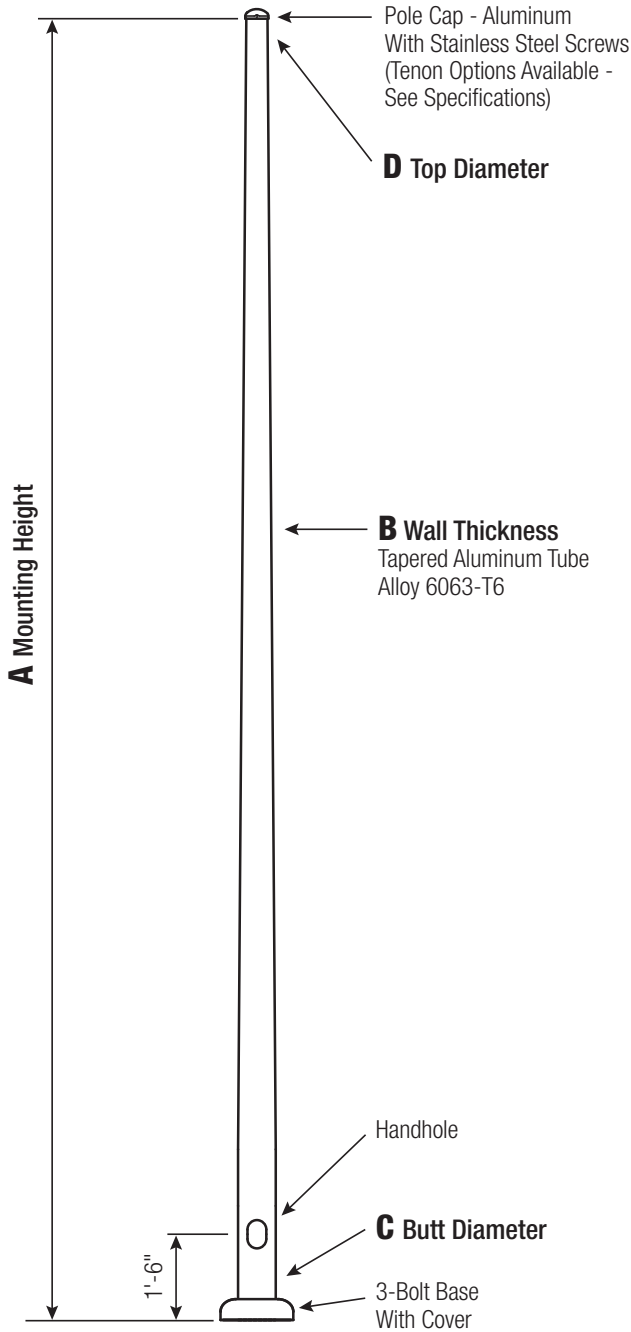

Satin Aluminum or Powder Coated Finish per Customer Specification.

| C BUTT DIA. | D TOP DIA. | F BOLT CIR. DIA. | G COVER DIA. | H BOLT PROJ. | I BOLT SIZE |
|----------------|---------------|---------------------|-----------------|-----------------|----------------|
| 4 | 3 | 7 | 9.0625 | 2 | .75 x 17 x 3 |
| 5 | 3 | 8 | 10.375 | 2 | .75 x 17 x 3 |

Dimensions in Inches

Pole

The pole shaft will be constructed of seamless extruded tube of 6063 Aluminum Alloy per the requirements of ASTM B221. The shaft assembly shall be full-length heat treated after base weld to produce a T6 temper.

Base Style

3-Bolt Cast Aluminum Base Flange of Alloy 356-T6 with Spun Aluminum Base Cover and Stainless Steel Hex Head Attaching Screw.



Handhole

2" x 4" Handhole with curved Lap Style Aluminum Door and two (2) Stainless Steel Self-Tapping Attaching Screws. A Grounding Provision incorporating a tapped 1/4"-20NC hole is provided opposite the Handhole.



Anchorage

Anchorage Kit will include three (3) L-shaped Steel Anchor Bolts conforming to AASHTO M314-90 Grade 55. Ten inches (10") of Threaded End will be Galvanized per ASTM A153. Kits will contain three (3) Hex Nuts, three (3) Lock Washers, and three (3) Flat Washers (all components Galvanized Steel). A bolt circle template will be provided.

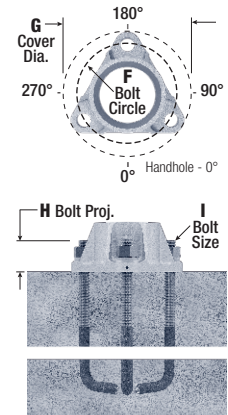

Vibration Damper

When determined necessary by Hapco, a Vibration Damper will be factory-installed inside the pole shaft. Customer specification of the damper is available.

Mounting Designation

Side Drill Mount

For Side Drill Mount applications specify luminaire type, quantity and orientation. A luminaire drilling template must be supplied at time of order.

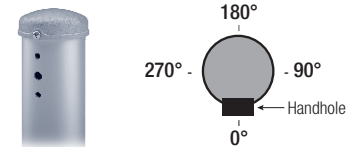

Tenon Mount - Welded or Spun

For Tenon Mount applications specify both Tenon diameter (2.375", 2.875", 3.5", etc.) and length (3", 4", etc.). Tenon style is factory option. Welded Tenon can be specified.



| A MTG. HGT. | B WALL THICKNESS | C BUTT DIA. | TOTAL LUM. WEIGHT | MAXIMUM EPA | | | | | | | | OLD CATALOG NUMBER | CATALOG NUMBER |
|-------------------|------------------------|-------------------|-------------------------|-------------|------|-----|-----|-----|-----|-----|----------|--------------------------|-------------------|
| | | | | 120 | 130 | 140 | 150 | 160 | 170 | 180 | | | |
| 06 | 0.125 | 4 | 95 | 11.2 | 9.4 | 8.1 | 6.9 | 6.0 | 5.3 | 4.7 | 76-001 | RTA06B4A3-**- | |
| 08 | 0.125 | 4 | 70 | 8.0 | 6.7 | 5.6 | 4.8 | 4.1 | 3.5 | 3.1 | 76-002 | RTA08B4A3-**- | |
| 10 | 0.125 | 4 | 55 | 5.9 | 4.8 | 4.0 | 3.3 | 2.8 | 2.3 | 2.0 | 76-003 | RTA10B4A3-**- | |
| 10 | 0.125 | 5 | 100 | 11.6 | 9.7 | 8.2 | 7.0 | 6.0 | 5.2 | 4.6 | 76-017 | RTA10B5A3-**- | |
| 12 | 0.125 | 4 | 45 | 4.4 | 3.5 | 2.8 | 2.3 | 1.8 | 1.4 | 1.2 | 76-004 | RTA12B4A3-**- | |
| 12 | 0.125 | 5 | 80 | 9.1 | 7.5 | 6.3 | 5.3 | 4.5 | 3.9 | 3.3 | 76-009 | RTA12B5A3-**- | |
| 12 | 0.156 | 5 | 95 | 11.5 | 9.6 | 8.0 | 6.8 | 5.8 | 5.1 | 4.4 | 76-009W3 | RTA12C5A3-**- | |
| 12 | 0.188 | 5 | 115 | 13.9 | 11.6 | 9.8 | 8.3 | 7.2 | 6.2 | 5.5 | 76-009W4 | RTA12D5A3-**- | |
| 14 | 0.125 | 4 | 40 | 3.2 | 2.4 | 1.8 | 1.4 | 1.0 | 0.7 | - | 76-005 | RTA14B4A3-**- | |
| 14 | 0.125 | 5 | 65 | 7.2 | 5.9 | 4.8 | 4.0 | 3.3 | 2.8 | 2.4 | 76-010 | RTA14B5A3-**- | |
| 14 | 0.156 | 5 | 80 | 9.3 | 7.6 | 6.3 | 5.3 | 4.5 | 3.8 | 3.3 | 76-021 | RTA14C5A3-**- | |
| 14 | 0.188 | 5 | 95 | 11.3 | 9.3 | 7.8 | 6.6 | 5.6 | 4.8 | 4.2 | 76-022 | RTA14D5A3-**- | |
| 16 | 0.125 | 4 | 40 | 2.2 | 1.5 | 1.0 | 0.6 | - | - | - | 76-006 | RTA16B4A3-**- | |
| 16 | 0.125 | 5 | 55 | 5.6 | 4.5 | 3.6 | 2.8 | 2.3 | 1.9 | 1.5 | 76-011 | RTA16B5A3-**- | |
| 16 | 0.156 | 5 | 65 | 7.4 | 6.0 | 4.9 | 4.0 | 3.3 | 2.8 | 2.3 | 76-029 | RTA16C5A3-**- | |
| 16 | 0.188 | 5 | 80 | 9.2 | 7.5 | 6.1 | 5.1 | 4.3 | 3.6 | 3.1 | 76-030 | RTA16D5A3-**- | |
| 18 | 0.125 | 5 | 45 | 4.2 | 3.2 | 2.5 | 1.9 | 1.4 | 1.1 | 0.8 | 76-007 | RTA18B5A3-**- | |
| 18 | 0.156 | 5 | 55 | 5.8 | 4.5 | 3.6 | 2.9 | 2.3 | 1.9 | 1.5 | 76-031 | RTA18C5A3-**- | |
| 18 | 0.188 | 5 | 65 | 7.3 | 5.8 | 4.7 | 3.8 | 3.2 | 2.6 | 2.2 | 76-032 | RTA18D5A3-**- | |
| 20 | 0.125 | 5 | 40 | 3.0 | 2.2 | 1.5 | 1.0 | 0.7 | - | - | 76-008 | RTA20B5A3-**- | |
| 20 | 0.156 | 5 | 45 | 4.4 | 3.3 | 2.5 | 1.9 | 1.5 | 1.1 | 0.8 | 76-033 | RTA20C5A3-**- | |
| 20 | 0.188 | 5 | 55 | 5.7 | 4.5 | 3.5 | 2.8 | 2.2 | 1.8 | 1.4 | 76-034 | RTA20D5A3-**- | |

Catalog Number System

The catalog number for Hapco poles utilizes the following identification system.

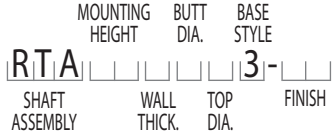

Catalog Number Example -

RTA 20 C 5 A 3 - 01

Round Tapered Aluminum, 20' Mounting Height, .156" Wall Thickness, 5" Butt Diameter, 3" Top Diameter, 3-Bolt Base, Satin Aluminum Finish.

Wall Thickness

- B = .125"
- C = .156"
- D = .188"

Butt Diameter

- 4 = 4"
- 5 = 5"

Top Diameter

- A = 3"

Base Style

- 3 = 3-Bolt Base

Finish

- 01 = Satin Aluminum
- BA = Black Powder Coat
- BH = White Powder Coat
- BM = Dark Bronze Powder Coat
- BV = Dark Green Powder Coat
- GC = Gray Powder Coat
- ** = Specify Finish

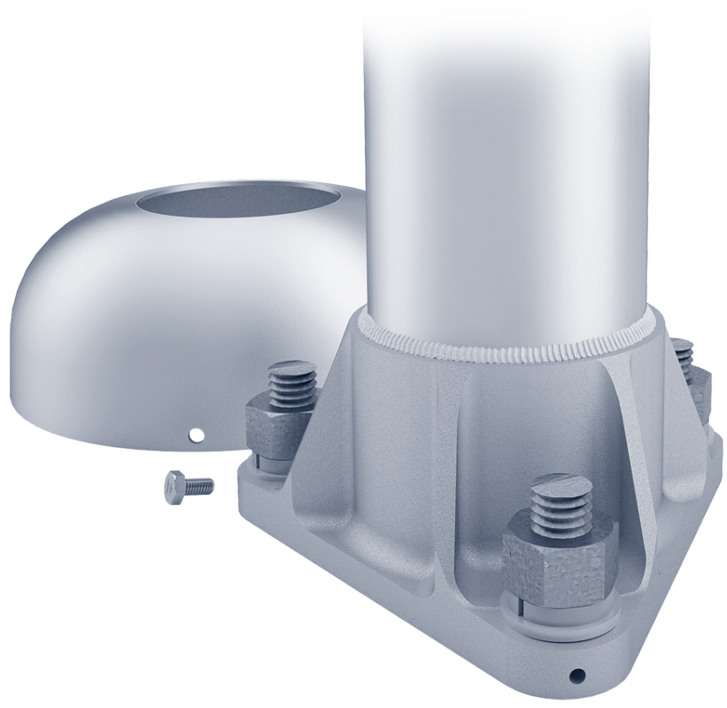

EPA Note:

EPA's based on symmetrically placed side mounted fixture(s) not exceeding height of the pole.

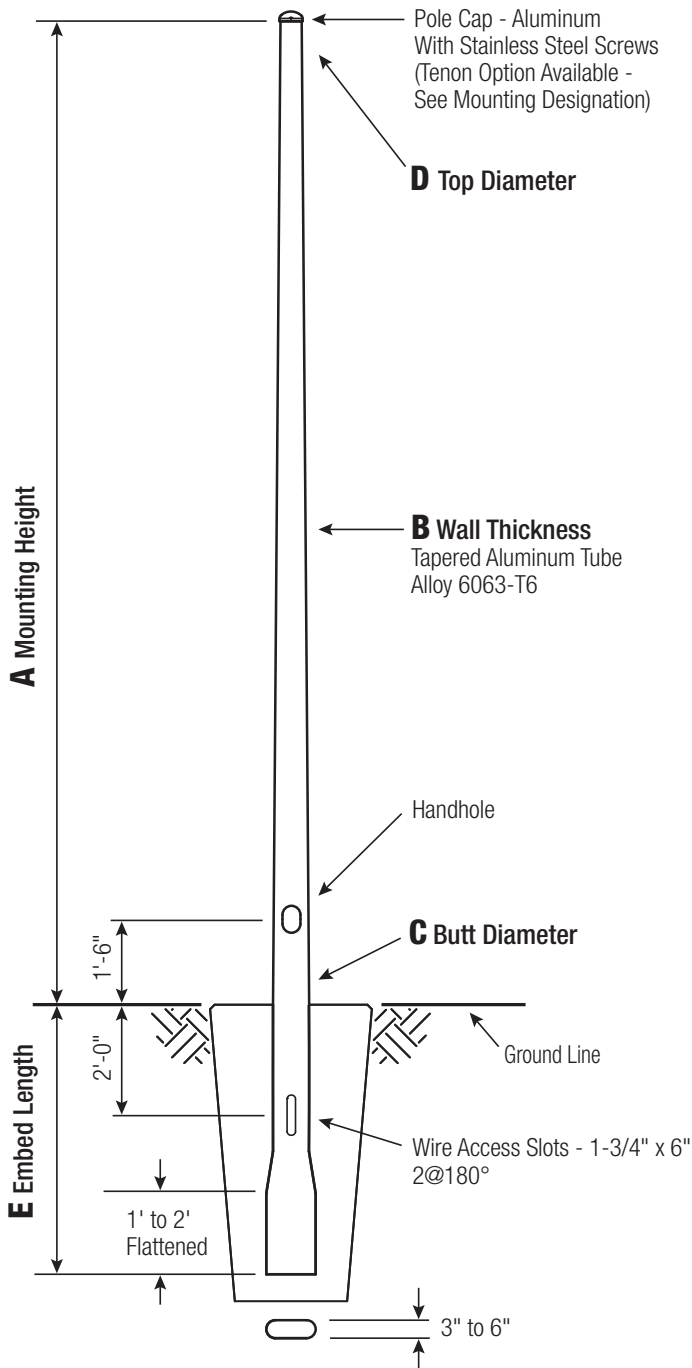

Satin Aluminum or Powder Coated Finish per Customer Specification.

| C BUTT DIA. | D TOP DIA. |
|-------------|------------|
| 5 | 3 |
| 6 | 4.5 |
| 7 | 4.5 |
| 8 | 4.5 |
| 9 | 4.5 |
| 10 | 6 |

C and D Dimensions in Inches

Pole

The pole shaft will be constructed of seamless extruded tube of 6063 Aluminum Alloy per the requirements of ASTM B221. The shaft assembly shall be full-length heat treated to produce a T6 temper.

Handhole

5" Butt Diameter - 2-1/2" x 5" Handhole with curved Lap Style Aluminum Door and two (2) SS Self-Tapping Attaching Screws. A Grounding Provision is provided as part of the handhole.

6" Butt Diameter - Reinforced, 3" x 5" curved Cast Aluminum Frame (Alloy 356-T6) with Aluminum Door and two (2) SS Hex Head Screws. A Grounding Provision incorporating a 3/8" diameter hole is provided opposite the Handhole.

7"+ Butt Diameters - Reinforced, 4" x 6" curved Cast Aluminum Frame (Alloy 356-T6) with Aluminum Door and two (2) SS Hex Head Screws. Reinforced Frame will contain a tapped 3/8"-16NC Grounding Provision.

Embed Detail

Direct Buried Pole bottom section on 6"+ butt diameter poles will be partially flattened into an anti-rotational, oval cross section. Wire access will be provided 24" below ground line. Soil conditions vary by site. Foundation requirements should be determined by a qualified Structural Engineer with knowledge of jobsite soil conditions.



Vibration Damper

When determined necessary by Hapco, a Vibration Damper will be factory-installed inside the pole shaft. Customer specification of the damper is available.

Mounting Designation

Side Drill Mount

For Side Drill Mount applications specify luminaire type, quantity and orientation. A luminaire drilling template must be supplied at time of order.

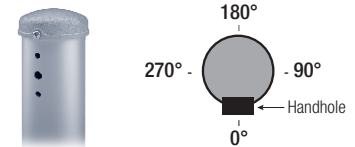

Tenon Mount - Welded or Spun

For Tenon Mount applications specify both Tenon diameter (2.375", 2.875", 3.5", etc.) and length (3", 4", etc.). Tenon style is factory option. Welded Tenon can be specified.



| A MTG. HGT. | B WALL THK. | C BUTT DIA. | E EMBED DEPTH | TOTAL LUM. WT. | MAXIMUM EPA | | | | | | | OLD CATALOG NUMBER | CATALOG NUMBER |
|-------------------|-------------------|-------------------|---------------------|----------------------|-------------|------|------|------|------|------|------|--------------------------|-------------------|
| | | | | | 120 | 130 | 140 | 150 | 160 | 170 | 180 | | |
| 10 | 0.125 | 5 | 4 | 110 | 9.9 | 8.2 | 6.9 | 5.9 | 5.0 | 4.4 | 3.8 | 87907-0310X | RTA10B5AD-** |
| 12 | 0.125 | 5 | 4 | 85 | 7.7 | 6.3 | 5.2 | 4.4 | 3.7 | 3.1 | 2.7 | 87907-0312X | RTA12B5AD-** |
| 14 | 0.125 | 5 | 4 | 70 | 6.0 | 4.8 | 3.9 | 3.2 | 2.6 | 2.2 | 1.8 | 87907-0314X | RTA14B5AD-** |
| 16 | 0.125 | 5 | 4 | 50 | 4.6 | 3.6 | 2.8 | 2.2 | 1.7 | 1.4 | 1.1 | 87907-0316X | RTA16B5AD-** |
| 18 | 0.125 | 5 | 4 | 40 | 3.3 | 2.4 | 1.8 | 1.3 | 0.9 | 0.6 | - | 87907-0318X | RTA18B5AD-** |
| 18 | 0.156 | 5 | 4 | 55 | 4.6 | 3.6 | 2.8 | 2.1 | 1.7 | 1.3 | 1.0 | | RTA18C5AD-** |
| 20 | 0.125 | 5 | 4 | 40 | 2.2 | 1.5 | 0.9 | - | - | - | - | | RTA20B5AD-** |
| 20 | 0.125 | 6 | 5 | 100 | 8.6 | 7.0 | 5.8 | 4.9 | 4.2 | 3.6 | 3.1 | 50-001 | RTA20B6BD-** |
| 20 | 0.156 | 6 | 6 | 135 | 11.5 | 9.4 | 7.9 | 6.8 | 5.8 | 5.0 | 4.4 | 50-002 | RTA20C6BD-** |
| 20 | 0.188 | 6 | 6 | 170 | 14.3 | 11.9 | 10.0 | 8.6 | 7.4 | 6.5 | 5.7 | 50-003 | RTA20D6BD-** |
| 20 | 0.156 | 7 | 6 | 210 | 17.3 | 14.4 | 12.2 | 10.5 | 9.1 | 8.0 | 7.0 | 50-004 | RTA20C7BD-** |
| 20 | 0.188 | 7 | 7 | 260 | 21.4 | 17.8 | 15.2 | 13.1 | 11.4 | 9.9 | 8.8 | 50-005 | RTA20D7BD-** |
| 20 | 0.156 | 8 | 7 | 295 | 24.1 | 20.2 | 17.2 | 14.9 | 12.9 | 11.3 | 10.0 | 50-006 | RTA20C8BD-** |
| 20 | 0.188 | 8 | 8 | 300 | 29.7 | 25.0 | 21.3 | 18.4 | 16.1 | 14.1 | 12.5 | 50-007 | RTA20D8BD-** |
| 25 | 0.156 | 6 | 6 | 85 | 7.0 | 5.5 | 4.5 | 3.8 | 3.2 | 2.7 | 2.2 | 50-062 | RTA25C6BD-** |
| 25 | 0.188 | 6 | 6 | 110 | 9.2 | 7.4 | 6.2 | 5.2 | 4.4 | 3.7 | 3.2 | 50-063 | RTA25D6BD-** |
| 25 | 0.156 | 7 | 6 | 140 | 11.6 | 9.4 | 7.9 | 6.7 | 5.7 | 4.9 | 4.3 | 50-064 | RTA25C7BD-** |
| 25 | 0.188 | 7 | 7 | 175 | 14.7 | 12.1 | 10.2 | 8.7 | 7.5 | 6.5 | 5.6 | 50-065 | RTA25D7BD-** |
| 25 | 0.156 | 8 | 7 | 205 | 16.9 | 14.0 | 11.8 | 10.1 | 8.7 | 7.6 | 6.6 | 50-066 | RTA25C8BD-** |
| 25 | 0.188 | 8 | 7 | 255 | 21.0 | 17.5 | 14.8 | 12.7 | 11.0 | 9.6 | 8.4 | 50-067 | RTA25D8BD-** |
| 25 | 0.219 | 8 | 8 | 300 | 24.9 | 20.8 | 17.7 | 15.2 | 13.2 | 11.6 | 10.2 | 50-068 | RTA25E8BD-** |
| 25 | 0.250 | 8 | 8 | 300 | 28.9 | 24.2 | 20.6 | 17.8 | 15.5 | 13.5 | 11.9 | 50-069 | RTA25F8BD-** |
| 30 | 0.156 | 7 | 6 | 90 | 7.5 | 5.9 | 4.8 | 3.9 | 3.3 | 2.7 | 2.3 | 50-124 | RTA30C7BD-** |
| 30 | 0.188 | 7 | 7 | 120 | 10.0 | 8.0 | 6.6 | 5.5 | 4.6 | 3.9 | 3.4 | 50-125 | RTA30D7BD-** |
| 30 | 0.156 | 8 | 7 | 140 | 11.8 | 9.5 | 7.9 | 6.7 | 5.7 | 4.9 | 4.2 | 50-126 | RTA30C8BD-** |
| 30 | 0.188 | 8 | 7 | 180 | 15.1 | 12.4 | 10.4 | 8.8 | 7.6 | 6.5 | 5.6 | 50-127 | RTA30D8BD-** |
| 30 | 0.219 | 8 | 8 | 220 | 18.2 | 15.0 | 12.7 | 10.8 | 9.3 | 8.1 | 7.0 | 50-128 | RTA30E8BD-** |
| 30 | 0.250 | 8 | 8 | 260 | 21.3 | 17.6 | 14.9 | 12.8 | 11.0 | 9.6 | 8.4 | 50-129 | RTA30F8BD-** |
| 30 | 0.188 | 9 | 8 | 255 | 20.9 | 17.4 | 14.7 | 12.6 | 10.9 | 9.4 | 8.2 | 50-131 | RTA30D9BD-** |
| 30 | 0.250 | 9 | 9 | 300 | 29.1 | 24.4 | 20.8 | 17.9 | 15.5 | 13.5 | 11.9 | 50-133 | RTA30F9BD-** |
| 30 | 0.188 | 10 | 9 | 300 | 27.7 | 23.3 | 19.8 | 17.0 | 14.7 | 12.8 | 11.1 | 50-139 | RTA30D1CD-** |
| 35 | 0.156 | 8 | 7 | 95 | 7.9 | 6.2 | 5.0 | 4.1 | 3.4 | 2.8 | 2.3 | 50-186 | RTA35C8BD-** |
| 35 | 0.188 | 8 | 7 | 130 | 10.6 | 8.5 | 7.0 | 5.8 | 4.9 | 4.1 | 3.5 | 50-187 | RTA35D8BD-** |
| 35 | 0.219 | 8 | 8 | 160 | 13.2 | 10.7 | 8.9 | 7.5 | 6.4 | 5.4 | 4.7 | 50-188 | RTA35E8BD-** |
| 35 | 0.250 | 8 | 8 | 190 | 15.8 | 12.9 | 10.8 | 9.1 | 7.8 | 6.7 | 5.8 | 50-189 | RTA35F8BD-** |
| 35 | 0.188 | 9 | 8 | 190 | 15.5 | 12.7 | 10.7 | 9.0 | 7.7 | 6.6 | 5.6 | 50-191 | RTA35D9BD-** |
| 35 | 0.250 | 9 | 9 | 270 | 22.2 | 18.4 | 15.6 | 13.3 | 11.4 | 9.9 | 8.6 | 50-193 | RTA35F9BD-** |
| 35 | 0.188 | 10 | 9 | 255 | 21.1 | 17.7 | 14.9 | 12.7 | 10.9 | 9.3 | 8.0 | 50-199 | RTA35D1CD-** |
| 35 | 0.219 | 10 | 9 | 300 | 25.4 | 21.3 | 18.1 | 15.4 | 13.3 | 11.5 | 9.9 | 50-200 | RTA35E1CD-** |
| 35 | 0.250 | 10 | 9 | 300 | 29.7 | 25.0 | 21.2 | 18.2 | 15.7 | 13.6 | 11.9 | 50-201 | RTA35F1CD-** |
| 35 | 0.312 | 10 | 10 | 300 | 38.1 | 32.2 | 27.4 | 23.6 | 20.5 | 17.8 | 15.6 | 50-202 | RTA35G1CD-** |
| 40 | 0.188 | 8 | 7 | 90 | 7.1 | 5.4 | 4.3 | 3.4 | 2.8 | 2.2 | 1.8 | 50-247 | RTA40D8BD-** |
| 40 | 0.219 | 8 | 8 | 115 | 9.3 | 7.3 | 5.9 | 4.8 | 4.0 | 3.3 | 2.7 | 50-248 | RTA40E8BD-** |
| 40 | 0.250 | 8 | 8 | 140 | 11.5 | 9.1 | 7.5 | 6.2 | 5.2 | 4.4 | 3.7 | 50-249 | RTA40F8BD-** |
| 40 | 0.188 | 9 | 8 | 135 | 11.3 | 9.1 | 7.5 | 6.2 | 5.2 | 4.3 | 3.6 | 50-251 | RTA40D9BD-** |
| 40 | 0.250 | 9 | 9 | 205 | 16.9 | 13.9 | 11.6 | 9.8 | 8.3 | 7.1 | 6.1 | 50-253 | RTA40F9BD-** |
| 40 | 0.188 | 10 | 9 | 190 | 16.1 | 13.4 | 11.2 | 9.4 | 7.9 | 6.7 | 5.6 | 50-259 | RTA40D1CD-** |
| 40 | 0.219 | 10 | 9 | 240 | 19.7 | 16.4 | 13.8 | 11.7 | 10.0 | 8.5 | 7.2 | 50-260 | RTA40E1CD-** |
| 40 | 0.250 | 10 | 9 | 280 | 23.3 | 19.4 | 16.4 | 14.0 | 12.0 | 10.3 | 8.8 | 50-261 | RTA40F1CD-** |
| 40 | 0.312 | 10 | 10 | 300 | 30.4 | 25.5 | 21.6 | 18.5 | 15.9 | 13.8 | 12.0 | 50-262 | RTA40G1CD-** |

Catalog Number System

The catalog number for Hapco poles utilizes the following identification system.

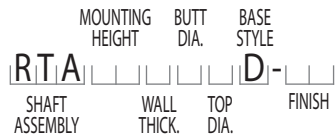

Catalog Number Example -

RTA 30 D 8 B D - 01

Round Tapered Aluminum, 30' Mounting Height, .188" Wall Thickness, 8" Butt Diameter, 4.5" Top Diameter, FBC Direct Buried, Satin Aluminum Finish.

Wall Thickness

- B = .125"
- C = .156"
- D = .188"
- E = .219"
- F = .250"
- G = .312"

Butt Diameter

- 5 = 5"
- 6 = 6"
- 7 = 7"
- 8 = 8"
- 9 = 9"
- 1 = 10"

Top Diameter

- A = 3"
- B = 4.5"
- C = 6"

Base Style

D = FBC Direct Buried

Finish

- O1 = Satin Aluminum
- BA = Black Powder Coat
- BH = White Powder Coat
- BM = Dark Bronze Powder Coat
- BV = Dark Green Powder Coat
- GC = Gray Powder Coat
- ** = Specify Finish

EPA Note:

EPA's based on symmetrically placed side mounted fixture(s) not exceeding height of the pole.

Embed Note:

Embed depths shown are calculated using the weight and EPA combination corresponding to the maximum windspeed available per pole. The calculation uses the assumption of a Class 3 soil type with a 12" diameter augered hole that is to be back-filled (preferably with chloride-free concrete or high density polyurethane foam). Embed depths are subject to change if the loading changes or if the wind speed changes. Please contact Hapco for help in determining an appropriate embed depth.

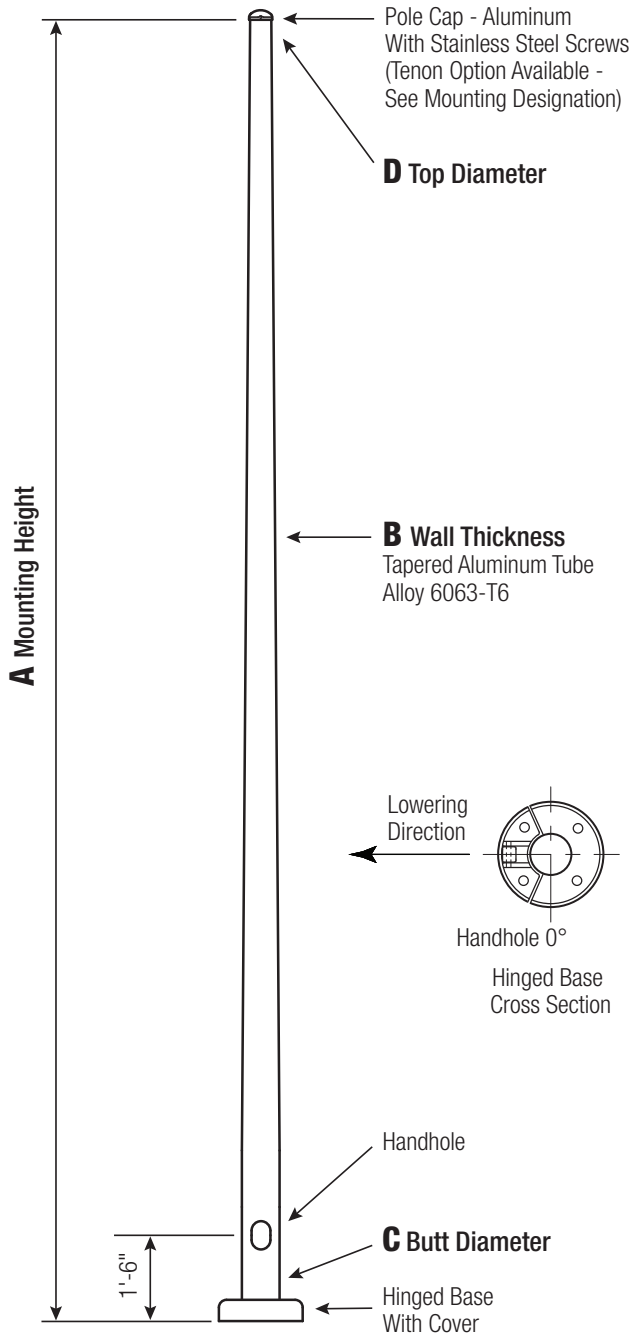

Satin Aluminum or Powder Coated Finish per Customer Specification.

| C BUTT DIA. | D TOP DIA. | F BOLT CIR. DIA. | G COVER DIA. | H BOLT PROJ. | I BOLT SIZE |
|----------------|---------------|---------------------|-----------------|-----------------|----------------|
| 4 | 3 | 7 | 9.75 | 2 | .75 x 17 x 3 |
| 5 | 3 | 8.5 | 11.25 | 2 | .75 x 17 x 3 |

Dimensions in Inches

Pole

The pole shaft will be constructed of seamless extruded tube of 6063 Aluminum Alloy per the requirements of ASTM B221. The shaft assembly shall be full-length heat treated after base weld to produce a T6 temper.

Base Style

Hinged Cast Aluminum Base Flange of Alloy 356-T6 with 2-Piece Cast Aluminum Base Cover and Stainless Steel Tamper-Resistant Attaching Screws.



Handhole

2" x 4" Handhole with curved Lap Style Aluminum Door and two (2) Stainless Steel Self-Tapping Attaching Screws. A Grounding Provision incorporating a tapped 1/4"-20NC hole is provided.



Anchorage

Anchorage Kit will include four (4) L-shaped Steel Anchor Bolts conforming to AASHTO M314-90 Grade 55. Ten inches (10") of Threaded End will be Galvanized per ASTM A153. Kits will contain four (4) Hex Nuts, four (4) Lock Washers, and four (4) Flat Washers (all components Galvanized Steel). A bolt circle template will be provided.

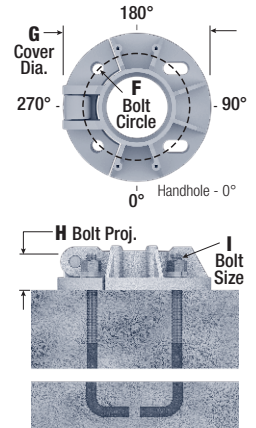

Vibration Damper

When determined necessary by Hapco, a Vibration Damper will be factory-installed inside the pole shaft. Customer specification of the damper is available.

Mounting Designation

Side Drill Mount

For Side Drill Mount applications specify luminaire type, quantity and orientation. A luminaire drilling template must be supplied at time of order.

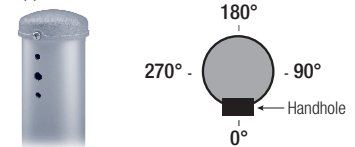

Tenon Mount - Welded or Spun

For Tenon Mount applications specify both Tenon diameter (2.375", 2.875", 3.5", etc.) and length (3", 4", etc.). Tenon style is factory option. Welded Tenon can be specified.

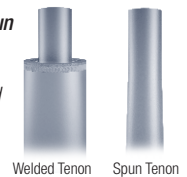

| A MTG. HGT. | B WALL THICKNESS | C BUTT DIA. | TOTAL LUM. WEIGHT | MAXIMUM EPA | | | | | | | | OLD CATALOG NUMBER | CATALOG NUMBER |
|-------------------|------------------------|-------------------|-------------------------|-------------|------|------|-----|-----|-----|-----|-----------|--------------------------|-------------------|
| | | | | 120 | 130 | 140 | 150 | 160 | 170 | 180 | | | |
| 06 | 0.125 | 4 | 110 | 11.1 | 9.4 | 8.0 | 6.9 | 6.0 | 5.2 | 4.6 | 73142-001 | RTA06B4AH-**- | |
| 08 | 0.125 | 4 | 80 | 7.9 | 6.6 | 5.6 | 4.7 | 4.1 | 3.5 | 3.1 | 73142-002 | RTA08B4AH-**- | |
| 08 | 0.156 | 4 | 95 | 9.8 | 8.2 | 7.0 | 6.0 | 5.1 | 4.5 | 3.9 | | RTA08C4AH-**- | |
| 08 | 0.188 | 4 | 115 | 11.7 | 9.8 | 8.3 | 7.1 | 6.2 | 5.4 | 4.7 | | RTA08D4AH-**- | |
| 10 | 0.125 | 4 | 60 | 5.9 | 4.8 | 4.0 | 3.3 | 2.8 | 2.3 | 2.0 | 73142-003 | RTA10B4AH-**- | |
| 10 | 0.156 | 4 | 75 | 7.4 | 6.1 | 5.1 | 4.3 | 3.6 | 3.1 | 2.6 | | RTA10C4AH-**- | |
| 10 | 0.188 | 4 | 90 | 8.8 | 7.3 | 6.2 | 5.2 | 4.4 | 3.8 | 3.3 | | RTA10D4AH-**- | |
| 10 | 0.125 | 5 | 115 | 11.5 | 9.6 | 8.1 | 6.9 | 6.0 | 5.2 | 4.6 | 73142-011 | RTA10B5AH-**- | |
| 10 | 0.156 | 5 | 145 | 14.4 | 12.1 | 10.2 | 8.8 | 7.6 | 6.6 | 5.8 | | RTA10C5AH-**- | |
| 12 | 0.125 | 4 | 45 | 4.4 | 3.5 | 2.8 | 2.3 | 1.8 | 1.4 | 1.2 | 73142-004 | RTA12B4AH-**- | |
| 12 | 0.156 | 4 | 60 | 5.6 | 4.6 | 3.7 | 3.0 | 2.5 | 2.1 | 1.7 | | RTA12C4AH-**- | |
| 12 | 0.188 | 4 | 70 | 6.8 | 5.6 | 4.6 | 3.8 | 3.2 | 2.7 | 2.2 | | RTA12D4AH-**- | |
| 12 | 0.125 | 5 | 90 | 9.1 | 7.5 | 6.2 | 5.3 | 4.5 | 3.8 | 3.3 | 73142-008 | RTA12B5AH-**- | |
| 12 | 0.156 | 5 | 115 | 11.5 | 9.5 | 8.0 | 6.8 | 5.8 | 5.0 | 4.4 | | RTA12C5AH-**- | |
| 14 | 0.125 | 4 | 40 | 3.2 | 2.4 | 1.8 | 1.4 | 1.0 | 0.7 | - | 73142-005 | RTA14B4AH-**- | |
| 14 | 0.156 | 4 | 45 | 4.3 | 3.4 | 2.6 | 2.1 | 1.6 | 1.2 | 1.0 | | RTA14C4AH-**- | |
| 14 | 0.188 | 4 | 55 | 5.3 | 4.2 | 3.4 | 2.7 | 2.2 | 1.7 | 1.4 | | RTA14D4AH-**- | |
| 14 | 0.125 | 5 | 75 | 7.2 | 5.8 | 4.8 | 3.9 | 3.3 | 2.8 | 2.3 | 73142-009 | RTA14B5AH-**- | |
| 14 | 0.156 | 5 | 95 | 9.2 | 7.6 | 6.3 | 5.2 | 4.4 | 3.8 | 3.3 | | RTA14C5AH-**- | |
| 16 | 0.156 | 4 | 40 | 3.1 | 2.3 | 1.7 | 1.2 | 0.8 | - | - | | RTA16C4AH-**- | |
| 16 | 0.188 | 4 | 45 | 4.0 | 3.1 | 2.4 | 1.8 | 1.3 | 1.0 | 0.7 | | RTA16D4AH-**- | |
| 16 | 0.125 | 5 | 60 | 5.6 | 4.4 | 3.5 | 2.8 | 2.3 | 1.9 | 1.5 | 73142-010 | RTA16B5AH-**- | |
| 16 | 0.156 | 5 | 75 | 7.4 | 5.9 | 4.8 | 4.0 | 3.3 | 2.7 | 2.3 | | RTA16C5AH-**- | |
| 18 | 0.125 | 5 | 45 | 4.2 | 3.2 | 2.5 | 1.9 | 1.4 | 1.1 | 0.8 | 73142-006 | RTA18B5AH-**- | |
| 18 | 0.156 | 5 | 60 | 5.7 | 4.5 | 3.6 | 2.9 | 2.3 | 1.9 | 1.5 | | RTA18C5AH-**- | |
| 20 | 0.125 | 5 | 40 | 3.0 | 2.2 | 1.5 | 1.0 | 0.7 | - | - | 73142-007 | RTA20B5AH-**- | |
| 20 | 0.156 | 5 | 50 | 4.4 | 3.3 | 2.5 | 1.9 | 1.4 | 1.1 | 0.8 | | RTA20C5AH-**- | |

Catalog Number System

The catalog number for Hapco poles utilizes the following identification system.

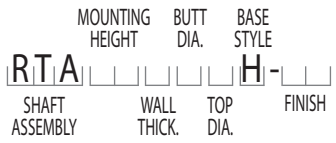

Catalog Number Example -

RTA 20 C 5 A H - 01

Round Tapered Aluminum, 20' Mounting Height, .156" Wall Thickness, 5" Butt Diameter, 3" Top Diameter, Hinged Base, Satin Aluminum Finish.

Wall Thickness

- B = .125"
- C = .156"
- D = .188"

Butt Diameter

- 4 = 4"
- 5 = 5"

Top Diameter

- A = 3"

Base Style

- H = Hinged Base

Finish

- 01 = Satin Aluminum
- BA = Black Powder Coat
- BH = White Powder Coat
- BM = Dark Bronze Powder Coat
- BV = Dark Green Powder Coat
- GC = Gray Powder Coat
- ** = Specify Finish

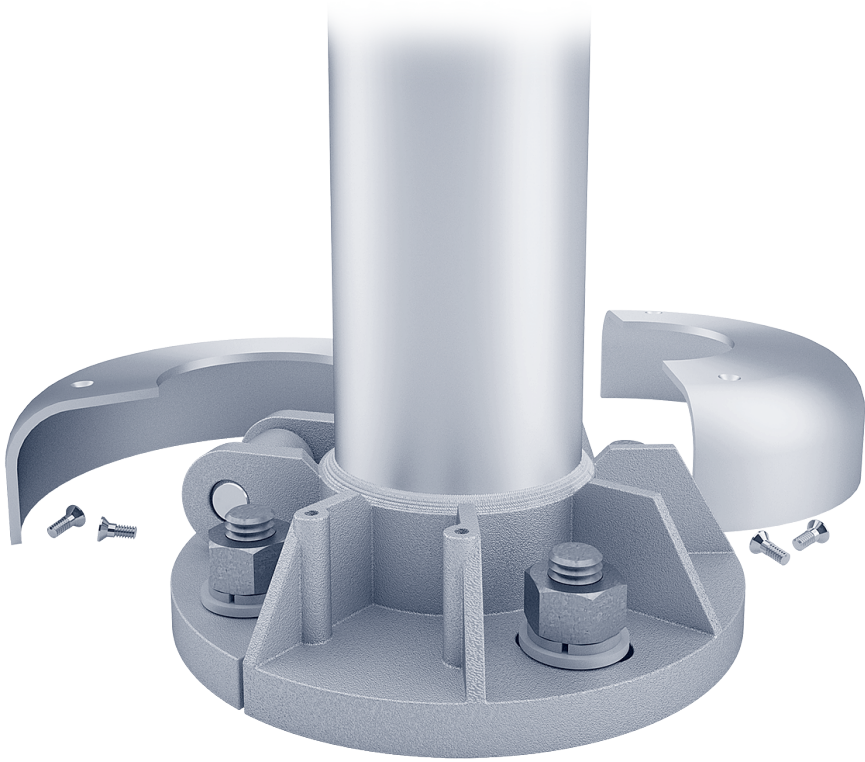

EPA Note:

EPA's based on symmetrically placed side mounted fixture(s) not exceeding height of the pole.

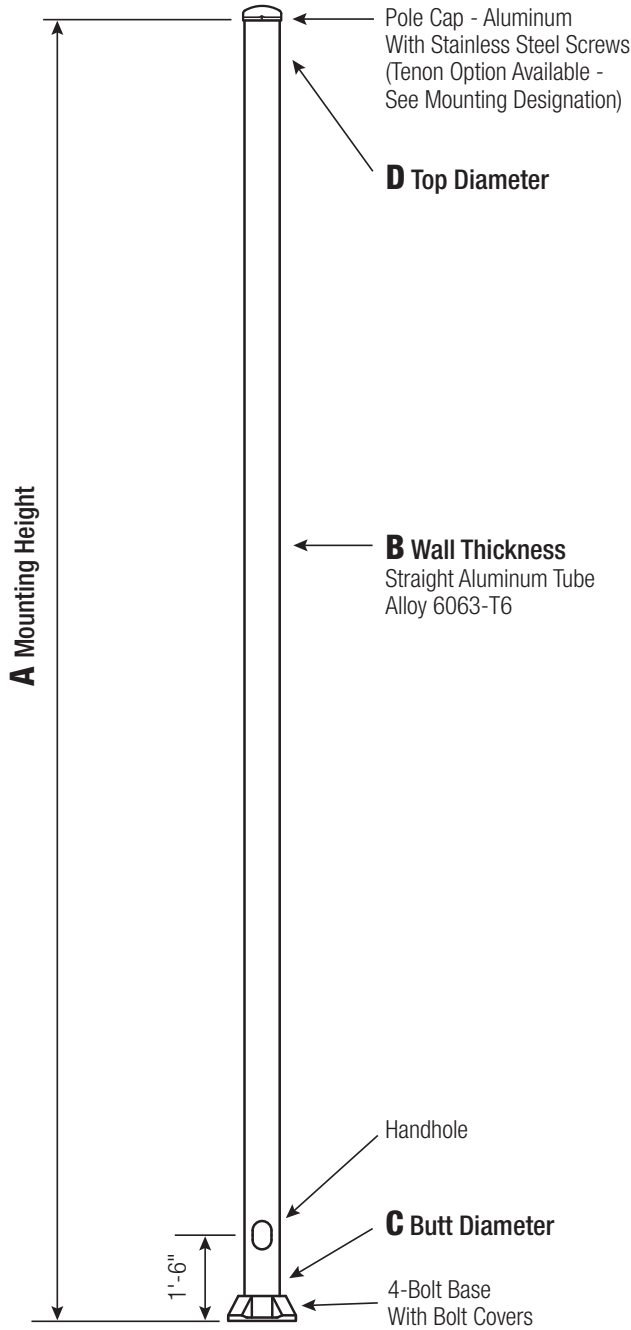

Satin Aluminum or Powder Coated Finish per Customer Specification.

| C BUTT DIA. | D TOP DIA. | F BOLT CIR. DIA. | G BASE SQ. | H BOLT PROJ. | I BOLT SIZE |
|----------------|---------------|---------------------|---------------|-----------------|----------------|
| 4 | 4 | 6.5 - 8 | 7.5 | 2 | .75 x 17 x 3 |
| 5 | 5 | 7.5 - 8 | 7.5 | 2 | .75 x 17 x 3 |
| 6 | 6 | 9 - 10 | 9.75 | 2.75 | .75 x 30 x 3* |
| 7 | 7 | 10 - 11 | 10.5 | 2.75 | 1 x 36 x 4 |
| 8 | 8 | 11 - 12 | 11.25 | 2.75 | 1 x 36 x 4 |
| 9 | 9 | 12.5 - 14 | 12.75 | 2.75 | 1 x 36 x 4 |
| 10 Up To .250" | 10 | 14 - 15 | 14 | 3.25 | 1 x 48 x 4 |
| 10 .312" | 10 | 14 - 15 | 14 | 3.25 | 1.25 x 48 x 6 |

*1" x 3/8" x 4" Anchor Bolts can be specified for 6" butt diameter poles.

Dimensions in Inches

Pole

The pole shaft will be constructed of seamless extruded tube of 6063 Aluminum Alloy per the requirements of ASTM B221. The shaft assembly shall be full-length heat treated after base weld to produce a T6 temper.

Base Style

4-Bolt Cast Aluminum Base Flange of Alloy 356-T6 with Aluminum Bolt Covers (Alloy 356-F) and Stainless Steel Hex Head Attaching Screws.



Handhole

4"-5" Butt Diameters - 2" x 4" Handhole with curved Lap Style Aluminum Door and two (2) SS Self-Tapping Attaching Screws. A Grounding Provision incorporating a tapped 1/4"-20NC hole is provided opposite the Handhole.

6" Butt Diameter - Reinforced, 3" x 5" curved Cast Aluminum Frame (Alloy 356-T6) with Aluminum Door and two (2) SS Hex Head Screws. A Grounding Provision incorporating a 3/8" diameter hole is provided opposite the Handhole.

7"+ Butt Diameters - Reinforced, 4" x 6" curved Cast Aluminum Frame (Alloy 356-T6) with Aluminum Door and two (2) SS Hex Head Screws. Reinforced Frame will contain a tapped 3/8"-16NC Grounding Provision.

Anchorage

Anchorage Kit will include four (4) L-shaped Steel Anchor Bolts conforming to AASHTO M314-90 Grade 55. Ten inches (10") of threaded end will be galvanized per ASTM A153.

Kits will contain four (4) Hex Nuts, four (4) Lock Washers, and four (4) Flat Washers (all components Galvanized Steel). A bolt circle template will be provided.

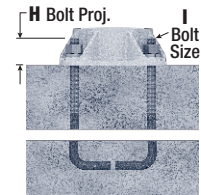
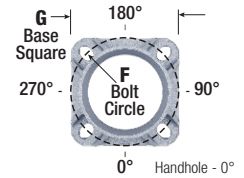

Vibration Damper

When determined necessary by Hapco, a Vibration Damper will be factory-installed inside the pole shaft. Customer specification of the damper is available.

Mounting Designation

Side Drill Mount

For Side Drill Mount applications specify luminaire type, quantity and orientation. A luminaire drilling template must be supplied at time of order.

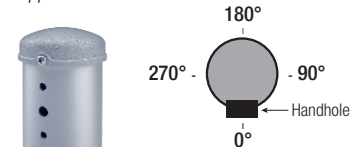

Tenon Mount

For Tenon Mount applications specify both Tenon diameter (2.375", 2.875", 3.5", etc.) and length (3", 4", etc.).



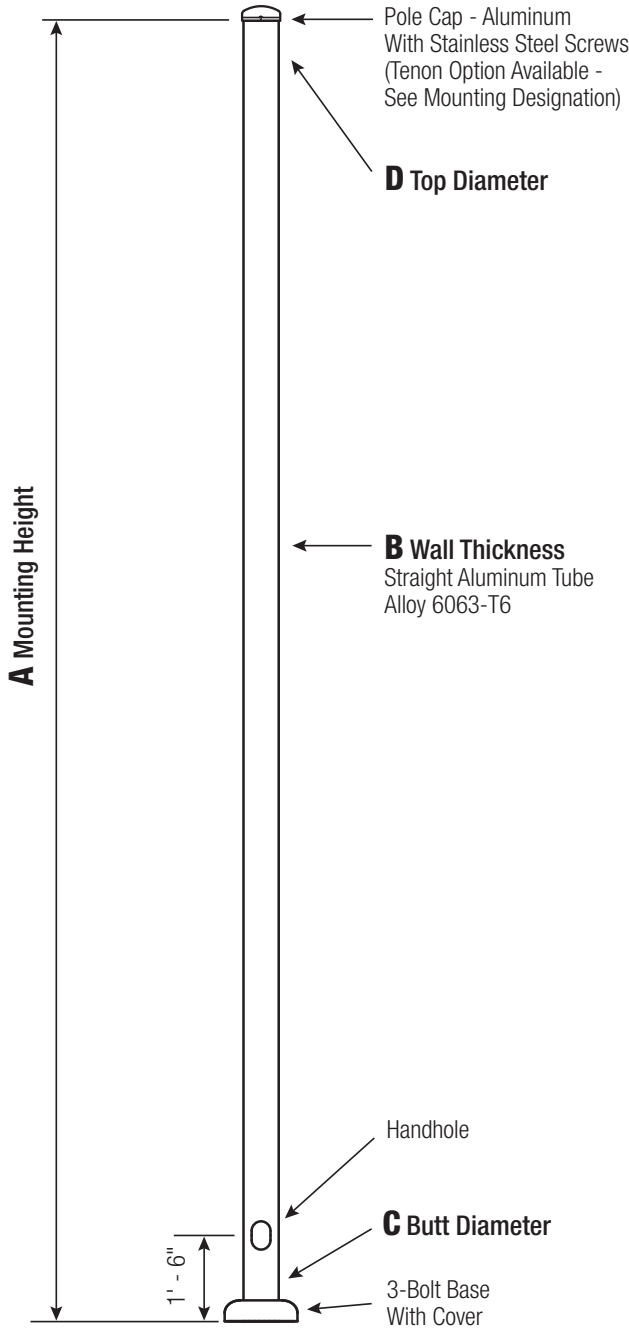

Satin Aluminum or Powder Coated Finish per Customer Specification.

| C BUTT DIA. | D TOP DIA. | F BOLT CIR. DIA. | G COVER DIA. | H BOLT PROJ. | I BOLT SIZE |
|----------------|---------------|---------------------|-----------------|-----------------|----------------|
| 4 | 4 | 7 | 9.0625 | 2 | .75 x 17 x 3 |
| 5 | 5 | 8 | 10.375 | 2 | .75 x 17 x 3 |

Dimensions in Inches

Pole

The pole shaft will be constructed of seamless extruded tube of 6063 Aluminum Alloy per the requirements of ASTM B221. The shaft assembly shall be full-length heat treated after base weld to produce a T6 temper.

Base Style

3-Bolt Cast Aluminum Base Flange of Alloy 356-T6 with Spun Aluminum Base Cover and Stainless Steel Hex Head Attaching Screw.



Handhole

2" x 4" Handhole with curved Lap Style Aluminum Door and two (2) Stainless Steel Self-Tapping Attaching Screws. A Grounding Provision incorporating a tapped 1/4"-20NC hole is provided opposite the Handhole.



Anchorage

Anchorage Kit will include three (3) L-shaped Steel Anchor Bolts conforming to AASHTO M314-90 Grade 55. Ten inches (10") of Threaded End will be Galvanized per ASTM A153. Kits will contain three (3) Hex Nuts, three (3) Lock Washers, and three (3) Flat Washers (all components Galvanized Steel). A bolt circle template will be provided.

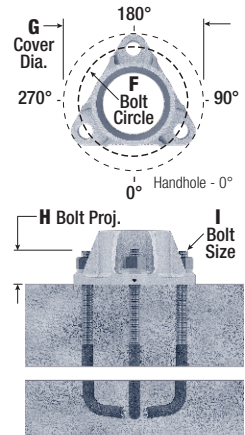

Vibration Damper

When determined necessary by Hapco, a Vibration Damper will be factory-installed inside the pole shaft. Customer specification of the damper is available.

Mounting Designation

Side Drill Mount

For Side Drill Mount applications specify luminaire type, quantity and orientation. A luminaire drilling template must be supplied at time of order.

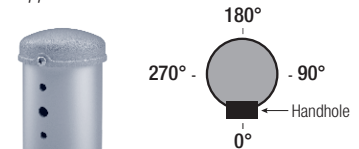

Tenon Mount

For Tenon Mount applications specify both Tenon diameter (2.375", 2.875", 3.5", etc.) and length (3", 4", etc.).



| A MTG. HGT. | B WALL THICKNESS | C BUTT DIA. | TOTAL LUM. WEIGHT | MAXIMUM EPA | | | | | | | | OLD CATALOG NUMBER | CATALOG NUMBER |
|-------------------|------------------------|-------------------|-------------------------|-------------|------|-----|-----|-----|-----|-----|---------|--------------------------|-------------------|
| | | | | 120 | 130 | 140 | 150 | 160 | 170 | 180 | | | |
| 06 | 0.125 | 4 | 110 | 11.0 | 9.3 | 7.9 | 6.8 | 5.9 | 5.2 | 4.6 | 76S-001 | RSA06B4-3-**- | |
| 08 | 0.125 | 4 | 80 | 7.8 | 6.5 | 5.4 | 4.6 | 4.0 | 3.5 | 3.1 | 76S-002 | RSA08B4-3-**- | |
| 10 | 0.125 | 4 | 60 | 5.6 | 4.6 | 3.8 | 3.1 | 2.6 | 2.3 | 2.0 | 76S-003 | RSA10B4-3-**- | |
| 10 | 0.125 | 5 | 110 | 11.1 | 9.4 | 8.0 | 6.9 | 6.0 | 5.3 | 4.6 | 76S-017 | RSA10B5-3-**- | |
| 12 | 0.125 | 4 | 45 | 4.1 | 3.2 | 2.5 | 2.0 | 1.6 | 1.4 | 1.2 | 76S-004 | RSA12B4-3-**- | |
| 12 | 0.125 | 5 | 85 | 8.5 | 7.1 | 6.0 | 5.2 | 4.5 | 3.9 | 3.4 | 76S-009 | RSA12B5-3-**- | |
| 12 | 0.156 | 5 | 110 | 10.9 | 9.2 | 7.8 | 6.7 | 5.8 | 5.1 | 4.5 | | RSA12C5-3-**- | |
| 12 | 0.188 | 5 | 135 | 13.2 | 11.1 | 9.5 | 8.2 | 7.1 | 6.3 | 5.5 | | RSA12D5-3-**- | |
| 14 | 0.125 | 4 | 40 | 2.9 | 2.1 | 1.5 | 1.0 | 0.8 | 0.6 | - | 76S-005 | RSA14B4-3-**- | |
| 14 | 0.125 | 5 | 70 | 6.5 | 5.4 | 4.5 | 3.8 | 3.3 | 2.8 | 2.5 | 76S-010 | RSA14B5-3-**- | |
| 14 | 0.156 | 5 | 90 | 8.6 | 7.1 | 6.0 | 5.1 | 4.4 | 3.9 | 3.4 | | RSA14C5-3-**- | |
| 14 | 0.188 | 5 | 110 | 10.6 | 8.8 | 7.5 | 6.4 | 5.6 | 4.9 | 4.3 | | RSA14D5-3-**- | |
| 16 | 0.125 | 5 | 55 | 4.9 | 4.0 | 3.3 | 2.7 | 2.3 | 2.0 | 1.7 | 76S-011 | RSA16B5-3-**- | |
| 16 | 0.125 | 5 | 55 | 4.9 | 4.0 | 3.3 | 2.7 | 2.3 | 2.0 | 1.7 | 76S-029 | RSA16C5-3-**- | |
| 16 | 0.188 | 5 | 85 | 8.4 | 6.9 | 5.9 | 5.0 | 4.3 | 3.7 | 3.2 | 76S-030 | RSA16D5-3-**- | |
| 18 | 0.125 | 5 | 40 | 3.5 | 2.7 | 2.2 | 1.8 | 1.5 | 1.2 | 1.0 | 76S-007 | RSA18B5-3-**- | |
| 18 | 0.156 | 5 | 55 | 5.0 | 4.0 | 3.3 | 2.8 | 2.3 | 2.0 | 1.7 | 76S-031 | RSA18C5-3-**- | |
| 18 | 0.188 | 5 | 70 | 6.5 | 5.3 | 4.4 | 3.7 | 3.2 | 2.7 | 2.3 | 76S-032 | RSA18D5-3-**- | |
| 20 | 0.125 | 5 | 40 | 2.2 | 1.6 | 1.2 | 0.9 | 0.7 | - | - | 76S-008 | RSA20B5-3-**- | |
| 20 | 0.156 | 5 | 45 | 3.6 | 2.8 | 2.2 | 1.8 | 1.5 | 1.2 | 1.0 | 76S-033 | RSA20C5-3-**- | |
| 20 | 0.188 | 5 | 55 | 4.9 | 3.9 | 3.2 | 2.7 | 2.2 | 1.9 | 1.6 | 76S-034 | RSA20D5-3-**- | |

Catalog Number System

The catalog number for Hapco poles utilizes the following identification system.

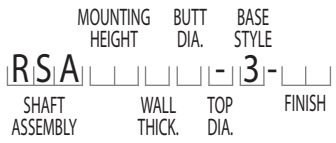

Catalog Number Example -

RSA 20 D 5 - 3 - 01

Round Straight Aluminum, 20' Mounting Height, .188" Wall Thickness, 5" Butt Diameter, No Taper, 3-Bolt Base, Satin Aluminum Finish.

Wall Thickness

- B = .125"
- C = .156"
- D = .188"

Butt Diameter

- 4 = 4"
- 5 = 5"

Top Diameter

- = No Taper

Base Style

- 3 = 3-Bolt Base

Finish

- O1 = Satin Aluminum
- BA = Black Powder Coat
- BH = White Powder Coat
- BM = Dark Bronze Powder Coat
- BV = Dark Green Powder Coat
- GC = Gray Powder Coat
- ** = Specify Finish

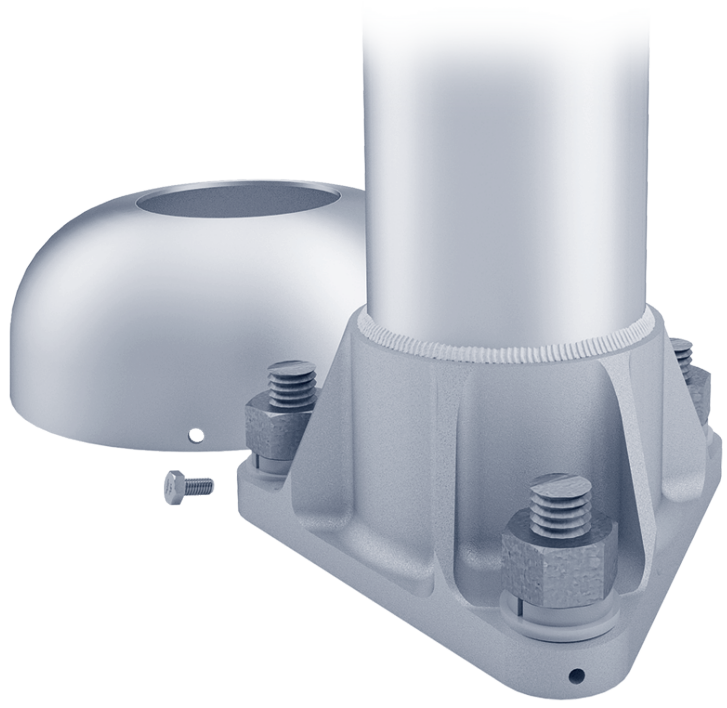

EPA Note:

EPA's based on symmetrically placed side mounted fixture(s) not exceeding height of the pole.

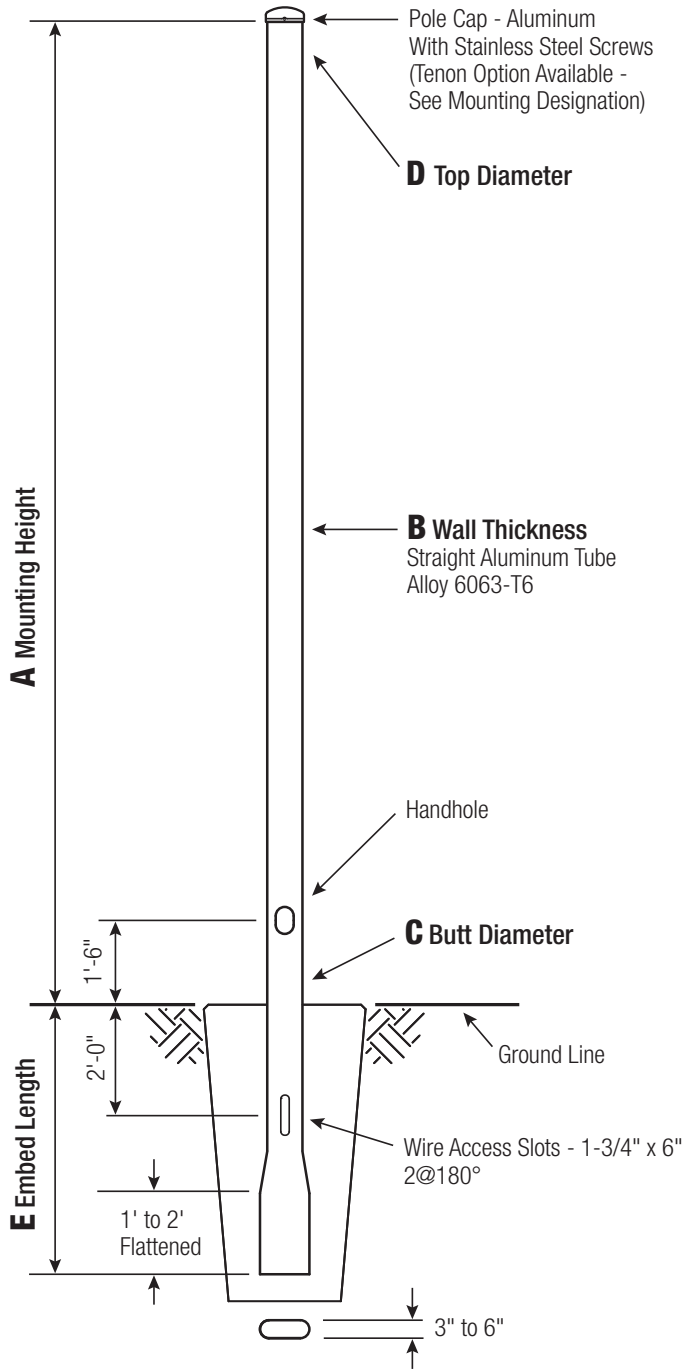

Satin Aluminum or Powder Coated Finish per Customer Specification.

| C BUTT DIA. | D TOP DIA. |
|-------------|------------|
| 4 | 4 |
| 5 | 5 |
| 6 | 6 |
| 7 | 7 |
| 8 | 8 |
| 9 | 9 |
| 10 | 10 |

C and D Dimensions in Inches

Pole

The pole shaft will be constructed of seamless extruded tube of 6063 Aluminum Alloy per the requirements of ASTM B221. The shaft assembly shall be full-length heat treated to produce a T6 temper.

Handhole

4" Butt Diameter - 2" x 4" Handhole with curved Lap Style Aluminum Door and two (2) SS Self-Tapping Attaching Screws. A Grounding Provision is provided as part of the handhole.

5" Butt Diameter - 2-1/2" x 5" Handhole with curved Lap Style Aluminum Door and two (2) SS Self-Tapping Attaching Screws. A Grounding Provision is provided as part of the handhole.

6" Butt Diameter - Reinforced, 3" x 5" curved Cast Aluminum Frame (Alloy 356-T6) with Aluminum Door and two (2) SS Hex Head Screws. A Grounding Provision incorporating a 3/8" diameter hole is provided opposite the Handhole.

7"+ Butt Diameters - Reinforced, 4" x 6" curved Cast Aluminum Frame (Alloy 356-T6) with Aluminum Door and two (2) SS Hex Head Screws. Reinforced Frame will contain a tapped 3/8"-16NC Grounding Provision.

Embed Detail

Direct Buried Pole bottom section on 6"+ butt diameter poles will be partially flattened into an anti-rotational, oval cross section. Wire access will be provided 24" below ground line. Soil conditions vary by site. Foundation requirements should be determined by a qualified Structural Engineer with knowledge of jobsite soil conditions.

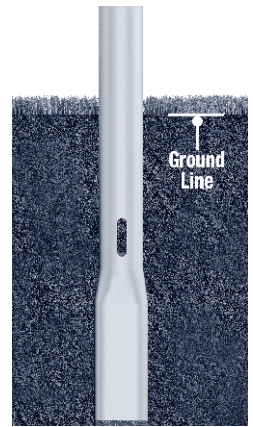

Vibration Damper

When determined necessary by Hapco, a Vibration Damper will be factory-installed inside the pole shaft. Customer specification of the damper is available.

Mounting Designation

Side Drill Mount

For Side Drill Mount applications specify luminaire type, quantity and orientation. A luminaire drilling template must be supplied at time of order.

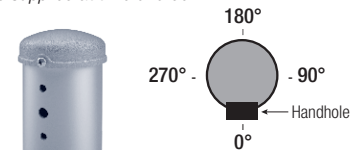

Tenon Mount

For Tenon Mount applications specify both Tenon diameter (2.375", 2.875", 3.5", etc.) and length (3", 4", etc.).



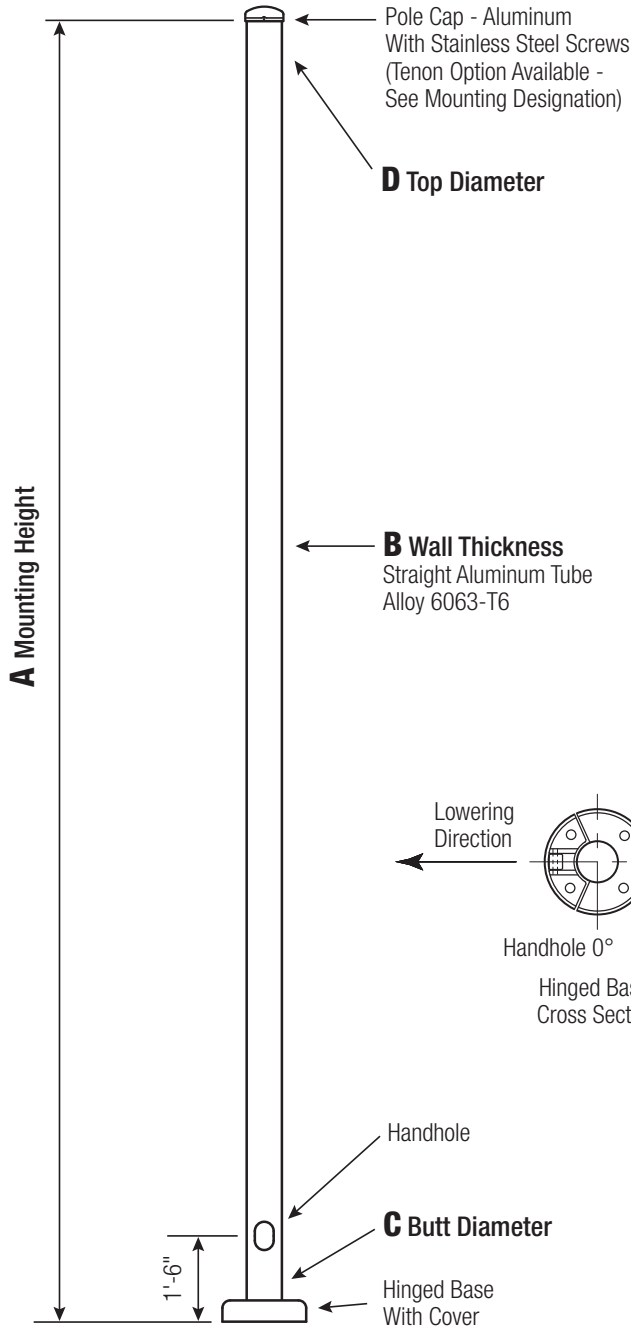

Satin Aluminum or Powder Coated Finish per Customer Specification.

| C BUTT DIA. | D TOP DIA. | F BOLT CIR. DIA. | G COVER DIA. | H BOLT PROJ. | I BOLT SIZE |
|----------------|---------------|---------------------|-----------------|-----------------|----------------|
| 4 | 4 | 7 | 9.75 | 2 | .75 x 17 x 3 |
| 5 | 5 | 8.5 | 11.25 | 2 | .75 x 17 x 3 |

Dimensions in Inches

Pole

The pole shaft will be constructed of seamless extruded tube of 6063 Aluminum Alloy per the requirements of ASTM B221. The shaft assembly shall be full-length heat treated after base weld to produce a T6 temper.

Base Style

Hinged Cast Aluminum Base Flange of Alloy 356-T6 with 2-Piece Cast Aluminum Base Cover and Stainless Steel Tamper-Resistant Attaching Screws.



Handhole

2" x 4" Handhole with curved Lap Style Aluminum Door and two (2) Stainless Steel Self-Tapping Attaching Screws. A Grounding Provision incorporating a tapped 11/4"-20NC hole is provided opposite the Handhole.



Anchorage

Anchorage Kit will include four (4) L-shaped Steel Anchor Bolts conforming to AASHTO M314-90 Grade 55. Ten inches (10") of Threaded End will be Galvanized per ASTM A153. Kits will contain four (4) Hex Nuts, four (4) Lock Washers, and four (4) Flat Washers (all components Galvanized Steel). A bolt circle template will be provided.

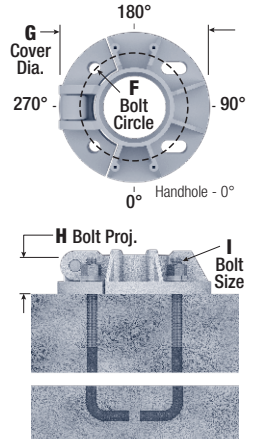

Vibration Damper

When determined necessary by Hapco, a Vibration Damper will be factory-installed inside the pole shaft. Customer specification of the damper is available.

Mounting Designation

Side Drill Mount

For Side Drill Mount applications specify luminaire type, quantity and orientation. A luminaire drilling template must be supplied at time of order.

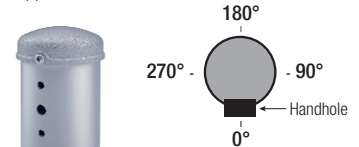

Tenon Mount

For Tenon Mount applications specify both Tenon diameter (2.375", 2.875", 3.5", etc.) and length (3", 4", etc.).



| A MTG. HGT. | B WALL THICKNESS | C BUTT DIA. | TOTAL LUM. WEIGHT | MAXIMUM EPA | | | | | | | | OLD CATALOG NUMBER | CATALOG NUMBER |
|-------------------|------------------------|-------------------|-------------------------|-------------|------|------|-----|-----|-----|-----|-----------|--------------------------|-------------------|
| | | | | 120 | 130 | 140 | 150 | 160 | 170 | 180 | | | |
| 06 | 0.125 | 4 | 110 | 11.0 | 9.3 | 7.9 | 6.8 | 5.9 | 5.2 | 4.6 | 73145-001 | RSA06B4-H-** | |
| 06 | 0.156 | 4 | 135 | 13.5 | 11.4 | 9.7 | 8.4 | 7.3 | 6.5 | 5.7 | | RSA06C4-H-** | |
| 06 | 0.188 | 4 | 160 | 15.9 | 13.5 | 11.5 | 9.9 | 8.7 | 7.7 | 6.8 | | RSA06D4-H-** | |
| 08 | 0.125 | 4 | 80 | 7.8 | 6.5 | 5.4 | 4.6 | 4.0 | 3.5 | 3.1 | 73145-002 | RSA08B4-H-** | |
| 08 | 0.156 | 4 | 95 | 9.7 | 8.1 | 6.8 | 5.8 | 5.0 | 4.4 | 3.9 | | RSA08C4-H-** | |
| 08 | 0.188 | 4 | 115 | 11.5 | 9.6 | 8.2 | 7.0 | 6.1 | 5.3 | 4.7 | | RSA08D4-H-** | |
| 10 | 0.125 | 4 | 60 | 5.6 | 4.6 | 3.8 | 3.1 | 2.6 | 2.3 | 2.0 | 73145-003 | RSA10B4-H-** | |
| 10 | 0.156 | 4 | 70 | 7.2 | 5.9 | 4.9 | 4.1 | 3.5 | 3.0 | 2.7 | | RSA10C4-H-** | |
| 10 | 0.188 | 4 | 85 | 8.6 | 7.1 | 5.9 | 5.0 | 4.3 | 3.8 | 3.3 | | RSA10D4-H-** | |
| 10 | 0.125 | 5 | 110 | 11.1 | 9.4 | 8.0 | 6.9 | 6.0 | 5.3 | 4.6 | | RSA10B5-H-** | |
| 10 | 0.156 | 5 | 140 | 14.0 | 11.8 | 10.1 | 8.7 | 7.6 | 6.7 | 5.9 | | RSA10C5-H-** | |
| 12 | 0.125 | 4 | 45 | 4.1 | 3.2 | 2.5 | 2.0 | 1.6 | 1.4 | 1.2 | 73145-004 | RSA12B4-H-** | |
| 12 | 0.156 | 4 | 55 | 5.4 | 4.3 | 3.5 | 2.8 | 2.3 | 2.0 | 1.7 | | RSA12C4-H-** | |
| 12 | 0.188 | 4 | 65 | 6.6 | 5.3 | 4.3 | 3.6 | 3.0 | 2.6 | 2.3 | | RSA12D4-H-** | |
| 12 | 0.125 | 5 | 85 | 8.5 | 7.1 | 6.0 | 5.2 | 4.5 | 3.9 | 3.4 | 73145-006 | RSA12B5-H-** | |
| 12 | 0.156 | 5 | 110 | 10.9 | 9.2 | 7.8 | 6.7 | 5.8 | 5.1 | 4.5 | | RSA12C5-H-** | |
| 14 | 0.125 | 4 | 40 | 2.9 | 2.1 | 1.5 | 1.0 | 0.8 | 0.6 | - | 73145-005 | RSA14B4-H-** | |
| 14 | 0.156 | 4 | 45 | 3.9 | 3.0 | 2.3 | 1.7 | 1.4 | 1.2 | 1.0 | | RSA14C4-H-** | |
| 14 | 0.188 | 4 | 55 | 5.0 | 3.9 | 3.1 | 2.4 | 2.0 | 1.7 | 1.4 | | RSA14D4-H-** | |
| 14 | 0.125 | 5 | 70 | 6.5 | 5.4 | 4.5 | 3.8 | 3.3 | 2.8 | 2.5 | 73145-007 | RSA14B5-H-** | |
| 14 | 0.156 | 5 | 90 | 8.5 | 7.1 | 6.0 | 5.1 | 4.4 | 3.9 | 3.4 | | RSA14C5-H-** | |
| 16 | 0.156 | 4 | 40 | 2.8 | 2.0 | 1.4 | 0.9 | 0.6 | - | - | | RSA16C4-H-** | |
| 16 | 0.188 | 4 | 40 | 3.7 | 2.8 | 2.0 | 1.4 | 1.1 | 0.9 | 0.7 | | RSA16D4-H-** | |
| 16 | 0.125 | 5 | 55 | 4.9 | 4.0 | 3.3 | 2.7 | 2.3 | 2.0 | 1.7 | 73145-008 | RSA16B5-H-** | |
| 16 | 0.156 | 5 | 70 | 6.6 | 5.5 | 4.6 | 3.9 | 3.3 | 2.8 | 2.5 | | RSA16C5-H-** | |
| 18 | 0.125 | 5 | 40 | 3.4 | 2.7 | 2.2 | 1.8 | 1.5 | 1.2 | 1.0 | 73145-009 | RSA18B5-H-** | |
| 18 | 0.156 | 5 | 55 | 5.0 | 4.0 | 3.3 | 2.8 | 2.3 | 2.0 | 1.7 | | RSA18C5-H-** | |
| 20 | 0.125 | 5 | 40 | 2.2 | 1.6 | 1.2 | 0.9 | 0.7 | - | - | 73145-010 | RSA20B5-H-** | |
| 20 | 0.156 | 5 | 45 | 3.6 | 2.8 | 2.2 | 1.8 | 1.5 | 1.2 | 1.0 | | RSA20C5-H-** | |

Catalog Number System

The catalog number for Hapco poles utilizes the following identification system.

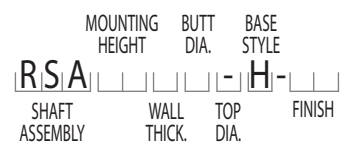

Catalog Number Example -

RSA 20 C 5 - H - 01

Round Straight Aluminum, 20' Mounting Height, .156" Wall Thickness, 5" Butt Diameter, No Taper, Hinged Base, Satin Aluminum Finish.

Wall Thickness

- B = .125"
- C = .156"
- D = .188"

Butt Diameter

- 4 = 4"
- 5 = 5"

Top Diameter

- = No Taper

Base Style

- H = Hinged Base

Finish

- 01 = Satin Aluminum
- BA = Black Powder Coat
- BH = White Powder Coat
- BM = Dark Bronze Powder Coat
- BV = Dark Green Powder Coat
- GC = Gray Powder Coat
- ** = Specify Finish

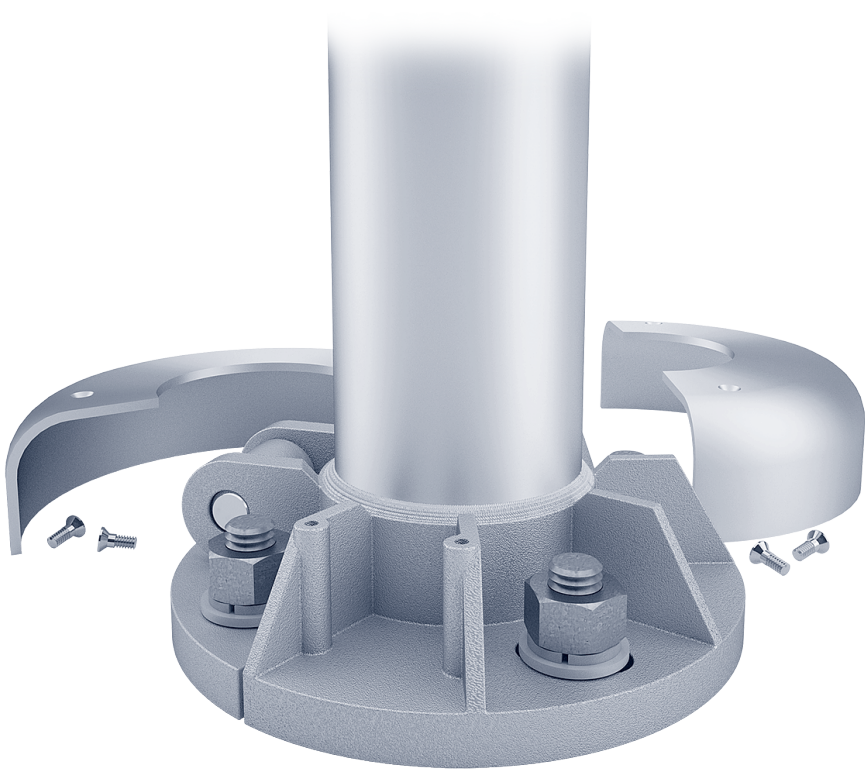

EPA Note:

EPA's based on symmetrically placed side mounted fixture(s) not exceeding height of the pole.

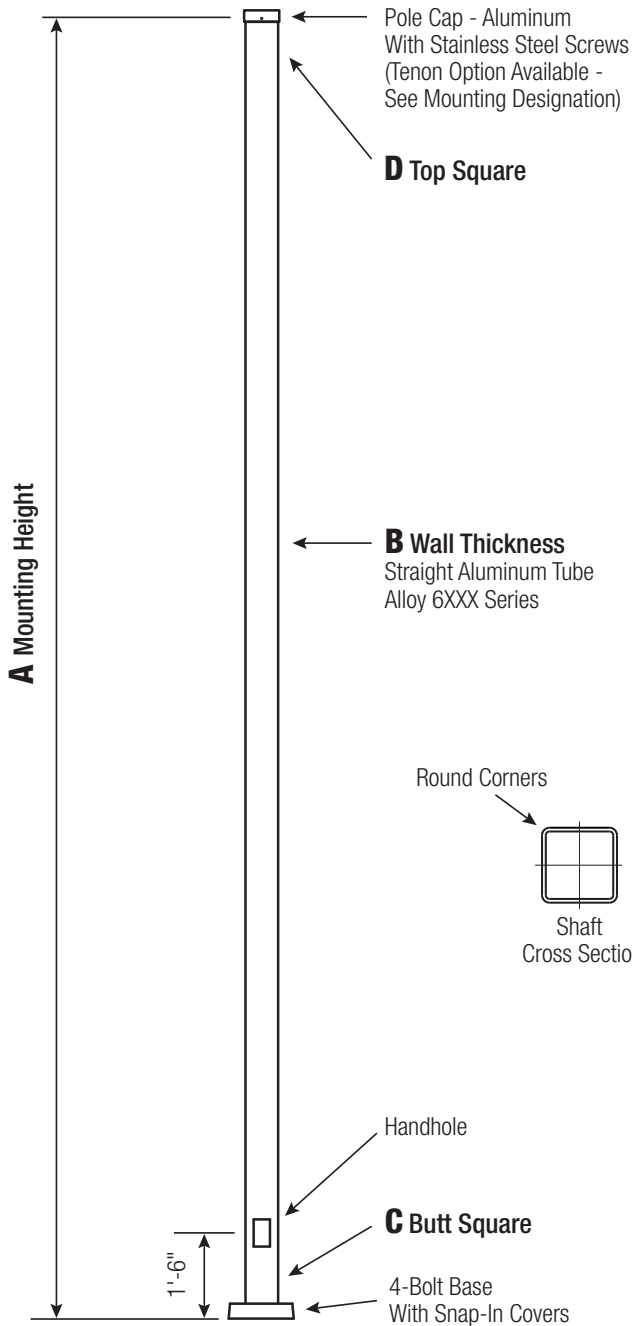

Satin Aluminum or Powder Coated Finish per Customer Specification.

| C BUTT SQ. | D TOP SQ. | F BOLT CIR. DIA. | G BASE SQ. | H BOLT PROJ. | I BOLT SIZE |
|---------------|--------------|---------------------|---------------|-----------------|----------------|
| 4 | 4 | 8.5 - 9.5 | 9.875 | 1.5 | .75 x 17 x 3 |
| 5 | 5 | 10.5 - 11.5 | 11.25 | 2 | .75 x 30 x 3 |
| 6 | 6 | 12 - 13 | 12.75 | 2.25 | 1 x 36 x 4 |
| 6.625 | 6.625 | 13 - 14 | 13.5 | 2.25 | 1 x 36 x 4 |

Dimensions in Inches

Pole

The pole shaft will be constructed of seamless extruded tube of 6XXX Series Aluminum Alloy per the requirements of ASTM B221. The shaft assembly shall be full-length heat treated after base weld.

Base Style

4-Bolt Cast Aluminum Base Flange of Alloy 356-T6 with Aluminum Snap-In Bolt Covers.

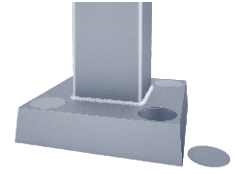

Handhole

4"-5" Butt Squares -
2" x 4" Handhole with square Lap Style Aluminum Door and two (2) Stainless Steel Self-Tapping Attaching Screws. A Grounding Provision incorporating a tapped 1/4"-20NC Grounding Provision is provided opposite the Handhole.



6"+ Butt Square -
3" x 5" Handhole with square Lap Style Aluminum Door and two (2) Stainless Steel Self-Tapping Attaching Screws. A Grounding Provision incorporating a tapped 1/4"-20NC Grounding Provision is provided opposite the Handhole.

Anchorage

Anchorage Kit will include four (4) L-shaped Steel Anchor Bolts conforming to AASHTO M314-90 Grade 55. Ten inches (10") of threaded end will be galvanized per ASTM A153. Kits will contain four (4) Hex Nuts, four (4) Lock Washers, and four (4) Flat Washers (all components Galvanized Steel). A bolt circle template will be provided.

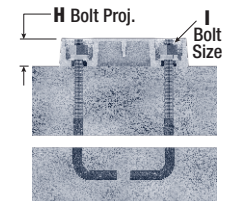
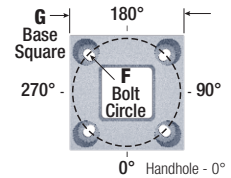

Vibration Damper

If determined necessary by Hapco, a top-mount, field installed First Mode Vibration Damper will be provided. Customer specification of the damper is available.

Mounting Designation

Side Drill Mount

For Side Drill Mount applications specify luminaire type, quantity and orientation. A luminaire drilling template must be supplied at time of order.

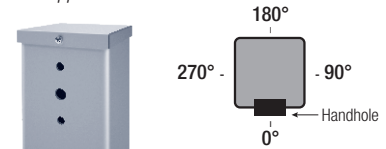

Tenon Mount

For Tenon Mount applications specify both Tenon diameter (2.375", 2.875", 3.5", etc.) and length (3", 4", etc.).



| A MTG. HGT. | B WALL THICKNESS | C BUTT SQ. | TOTAL LUM. WEIGHT | MAXIMUM EPA | | | | | | | | OLD CATALOG NUMBER | CATALOG NUMBER |
|-------------------|------------------------|------------------|-------------------------|-------------|------|------|-----|-----|-----|-----|--------|--------------------------|-------------------|
| | | | | 120 | 130 | 140 | 150 | 160 | 170 | 180 | | | |
| 08 | 0.125 | 4 | 90 | 10.6 | 8.8 | 7.4 | 6.3 | 5.4 | 4.7 | 4.0 | 11-043 | SSA08B4-4-**- | |
| 10 | 0.125 | 4 | 70 | 7.7 | 6.3 | 5.2 | 4.3 | 3.6 | 3.0 | 2.5 | 11-063 | SSA10B4-4-**- | |
| 10 | 0.188 | 4 | 100 | 11.6 | 9.7 | 8.1 | 6.8 | 5.8 | 5.0 | 4.3 | 11-064 | SSA10D4-4-**- | |
| 12 | 0.125 | 4 | 55 | 5.6 | 4.5 | 3.6 | 2.9 | 2.3 | 1.8 | 1.4 | 11-083 | SSA12B4-4-**- | |
| 12 | 0.188 | 4 | 75 | 8.8 | 7.2 | 6.0 | 4.9 | 4.1 | 3.4 | 2.8 | 11-084 | SSA12D4-4-**- | |
| 12 | 0.188 | 5 | 140 | 17.0 | 14.1 | 11.7 | 9.9 | 8.3 | 7.1 | 6.0 | 11-087 | SSA12D5-4-**- | |
| 14 | 0.125 | 4 | 45 | 4.0 | 3.1 | 2.3 | 1.7 | 1.2 | 0.8 | - | 11-103 | SSA14B4-4-**- | |
| 14 | 0.188 | 4 | 65 | 6.7 | 5.4 | 4.3 | 3.5 | 2.8 | 2.2 | 1.7 | 11-104 | SSA14D4-4-**- | |
| 14 | 0.188 | 5 | 115 | 13.4 | 10.9 | 9.0 | 7.4 | 6.1 | 5.0 | 4.1 | 11-107 | SSA14D5-4-**- | |
| 15 | 0.125 | 4 | 40 | 3.4 | 2.5 | 1.8 | 1.2 | 0.8 | - | - | 11-123 | SSA15B4-4-**- | |
| 15 | 0.188 | 4 | 55 | 5.9 | 4.6 | 3.6 | 2.8 | 2.2 | 1.6 | 1.2 | 11-124 | SSA15D4-4-**- | |
| 15 | 0.188 | 5 | 100 | 11.9 | 9.6 | 7.8 | 6.3 | 5.1 | 4.1 | 3.3 | 11-127 | SSA15D5-4-**- | |
| 16 | 0.125 | 4 | 40 | 2.7 | 1.9 | 1.3 | 0.8 | - | - | - | 11-143 | SSA16B4-4-**- | |
| 16 | 0.188 | 4 | 50 | 5.0 | 3.9 | 3.0 | 2.3 | 1.7 | 1.2 | 0.7 | 11-144 | SSA16D4-4-**- | |
| 16 | 0.188 | 5 | 90 | 10.5 | 8.4 | 6.7 | 5.3 | 4.2 | 3.3 | 2.5 | 11-147 | SSA16D5-4-**- | |
| 18 | 0.125 | 4 | 40 | 1.6 | 0.9 | - | - | - | - | - | 11-163 | SSA18B4-4-**- | |
| 18 | 0.188 | 4 | 45 | 3.6 | 2.6 | 1.9 | 1.2 | 0.7 | - | - | 11-164 | SSA18D4-4-**- | |
| 18 | 0.250 | 4 | 55 | 5.3 | 4.1 | 3.1 | 2.3 | 1.7 | 1.1 | 0.7 | 11-165 | SSA18F4-4-**- | |
| 18 | 0.188 | 5 | 75 | 8.0 | 6.2 | 4.8 | 3.6 | 2.6 | 1.8 | 1.2 | 11-167 | SSA18D5-4-**- | |
| 20 | 0.125 | 4 | 40 | 0.7 | - | - | - | - | - | - | 11-183 | SSA20B4-4-**- | |
| 20 | 0.188 | 4 | 40 | 2.4 | 1.6 | 0.9 | - | - | - | - | 11-184 | SSA20D4-4-**- | |
| 20 | 0.250 | 4 | 45 | 3.9 | 2.8 | 2.0 | 1.3 | 0.7 | - | - | 11-185 | SSA20F4-4-**- | |
| 20 | 0.188 | 5 | 60 | 6.0 | 4.4 | 3.1 | 2.1 | 1.3 | 0.6 | - | 11-187 | SSA20D5-4-**- | |
| 20 | 0.250 | 5 | 80 | 8.9 | 6.9 | 5.3 | 4.0 | 2.9 | 2.1 | 1.3 | 11-188 | SSA20F5-4-**- | |
| 20 | 0.188 | 6 | 80 | 8.7 | 6.5 | 4.7 | 3.3 | 2.1 | 1.2 | - | 11-190 | SSA20D6-4-**- | |
| 20 | 0.250 | 6 | 115 | 12.9 | 10.0 | 7.8 | 6.0 | 4.5 | 3.3 | 2.2 | 11-191 | SSA20F6-4-**- | |
| 25 | 0.188 | 5 | 40 | 2.1 | 0.9 | - | - | - | - | - | 11-247 | SSA25D5-4-**- | |
| 25 | 0.250 | 5 | 50 | 4.2 | 2.8 | 1.6 | 0.6 | - | - | - | 11-248 | SSA25F5-4-**- | |
| 25 | 0.188 | 6 | 45 | 3.4 | 1.8 | - | - | - | - | - | 11-250 | SSA25D6-4-**- | |
| 25 | 0.250 | 6 | 70 | 6.6 | 4.4 | 2.7 | 1.4 | - | - | - | 11-251 | SSA25F6-4-**- | |
| 25 | 0.250 | 6.625 | 95 | 9.9 | 7.1 | 4.9 | 3.1 | 1.6 | - | - | 11-254 | SSA25FJ-4-**- | |
| 30 | 0.250 | 6 | 40 | 2.0 | - | - | - | - | - | - | 11-291 | SSA30F6-4-**- | |
| 30 | 0.250 | 6.625 | 55 | 4.2 | 2.0 | - | - | - | - | - | 11-294 | SSA30FJ-4-**- | |

Catalog Number System

The catalog number for Hapco poles utilizes the following identification system.

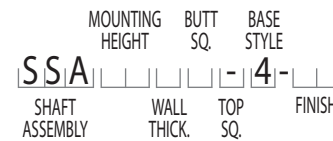

Catalog Number Example -

SSA 20 D 5 - 4 - BA

Square Straight Aluminum, 20' Mounting Height, .188" Wall Thickness, 5" Butt Square, No Taper, 4-Bolt Base, Black Powder Coat Finish.

Wall Thickness

- B = .125"
- D = .188"
- F = .250"

Butt Square

- 4 = 4"
- 5 = 5"
- 6 = 6"
- J = 6-5/8"

Top Square

- = No Taper

Base Style

- 4 = 4-Bolt Base

Finish

- BA = Black Powder Coat
- BH = White Powder Coat
- BM = Dark Bronze Powder Coat
- BV = Dark Green Powder Coat
- GC = Gray Powder Coat
- ** = Specify Finish

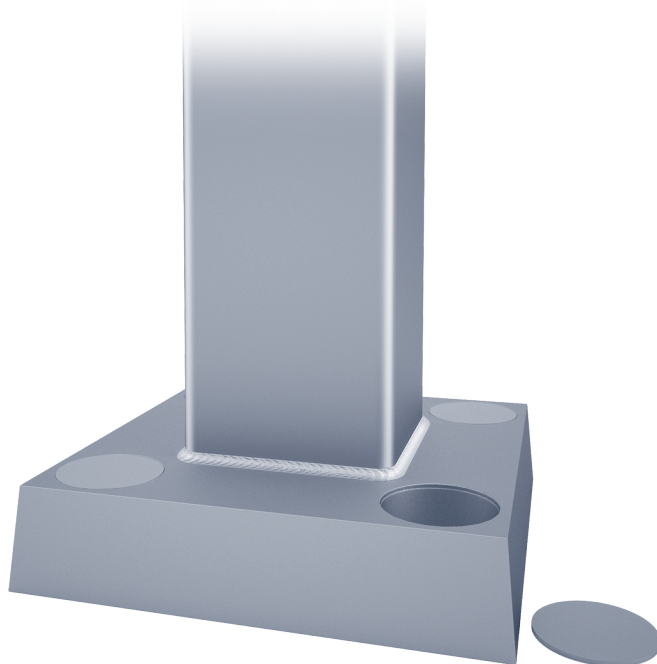

EPA Note:

EPA's based on symmetrically placed side mounted fixture(s) not exceeding height of the pole.

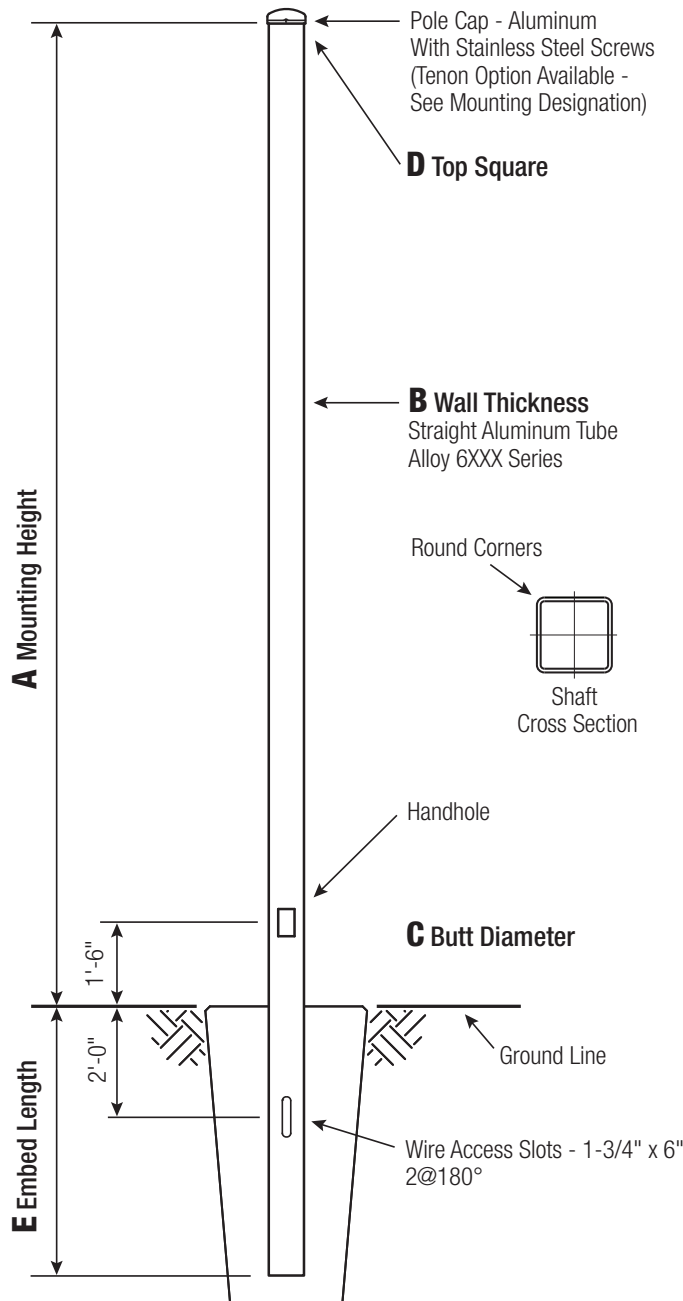

Satin Aluminum or Powder Coated Finish per Customer Specification.

| C BUTT Sq. | D TOP Sq. |
|---------------|--------------|
| 4 | 4 |
| 5 | 5 |
| 6 | 6 |
| 6.625 | 6.625 |

C and D Dimensions in Inches

Pole

The pole shaft will be constructed of seamless extruded tube of 6XXX Series Aluminum Alloy per the requirements of ASTM B221. The shaft assembly shall be full-length heat treated after base weld.

Handhole

4"-5" Butt Squares -
2" x 4" Handhole with square Lap Style Aluminum Door and two (2) Stainless Steel Self-Tapping Attaching Screws. A Grounding Provision incorporating a tapped 1/4"-20NC Grounding Provision is provided opposite the Handhole.



6"+ Butt Square -
3" x 5" Handhole with square Lap Style Aluminum Door and two (2) Stainless Steel Self-Tapping Attaching Screws. A Grounding Provision incorporating a tapped 1/4"-20NC Grounding Provision is provided opposite the Handhole.

Embed Detail

Direct Buried Pole wire access will be provided 24" below ground line. Soil conditions vary by site. Foundation requirements should be determined by a qualified Structural Engineer with knowledge of jobsite soil conditions.

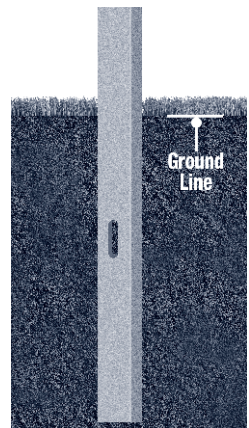

Vibration Damper

If determined necessary by Hapco, a top-mount, field installed First Mode Vibration Damper will be provided. Customer specification of the damper is available.

Mounting Designation

Side Drill Mount

For Side Drill Mount applications specify luminaire type, quantity and orientation. A luminaire drilling template must be supplied at time of order.

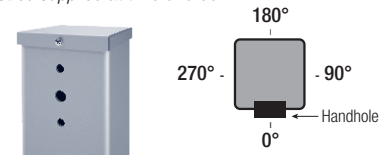

Tenon Mount

For Tenon Mount applications specify both Tenon diameter (2.375", 2.875", 3.5", etc.) and length (3", 4", etc.).



| A MTG. HGT. | B WALL THK. | C BUTT SQ. | E EMBED DEPTH | TOTAL LUM. WT. | MAXIMUM EPA | | | | | | | | CATALOG NUMBER |
|-------------------|-------------------|------------------|---------------------|----------------------|-------------|------|------|-----|-----|-----|-----|--------------|----------------|
| | | | | | 120 | 130 | 140 | 150 | 160 | 170 | 180 | | |
| 8 | 0.125 | 4 | 5 | 90 | 10.6 | 8.8 | 7.4 | 6.3 | 5.4 | 4.7 | 4.0 | SSA08B4-D.** | |
| 10 | 0.125 | 4 | 4 | 70 | 7.7 | 6.3 | 5.2 | 4.3 | 3.6 | 3.0 | 2.5 | SSA10B4-D.** | |
| 10 | 0.188 | 4 | 5 | 100 | 11.6 | 9.6 | 8.1 | 6.8 | 5.8 | 5.0 | 4.3 | SSA10D4-D.** | |
| 12 | 0.125 | 4 | 4 | 55 | 5.6 | 4.5 | 3.6 | 2.9 | 2.3 | 1.8 | 1.4 | SSA12B4-D.** | |
| 12 | 0.188 | 4 | 5 | 75 | 8.8 | 7.2 | 6.0 | 4.9 | 4.1 | 3.4 | 2.8 | SSA12D4-D.** | |
| 12 | 0.188 | 5 | 6 | 140 | 17.0 | 14.1 | 11.7 | 9.9 | 8.3 | 7.1 | 6.0 | SSA12D5-D.** | |
| 14 | 0.125 | 4 | 4 | 45 | 4.0 | 3.1 | 2.3 | 1.7 | 1.2 | 0.8 | - | SSA14B4-D.** | |
| 14 | 0.188 | 4 | 5 | 65 | 6.7 | 5.4 | 4.3 | 3.5 | 2.8 | 2.2 | 1.7 | SSA14D4-D.** | |
| 14 | 0.188 | 5 | 6 | 115 | 13.4 | 10.9 | 9.0 | 7.4 | 6.1 | 5.0 | 4.1 | SSA14D5-D.** | |
| 15 | 0.125 | 4 | 4 | 40 | 3.4 | 2.5 | 1.8 | 1.2 | 0.8 | - | - | SSA15B4-D.** | |
| 15 | 0.188 | 4 | 5 | 55 | 5.9 | 4.6 | 3.6 | 2.8 | 2.2 | 1.6 | 1.2 | SSA15D4-D.** | |
| 15 | 0.188 | 5 | 6 | 100 | 11.9 | 9.6 | 7.8 | 6.3 | 5.1 | 4.1 | 3.3 | SSA15D5-D.** | |
| 16 | 0.125 | 4 | 4 | 40 | 2.7 | 1.9 | 1.3 | 0.8 | - | - | - | SSA16B4-D.** | |
| 16 | 0.188 | 4 | 5 | 50 | 5.0 | 3.9 | 3.0 | 2.3 | 1.7 | 1.2 | 0.7 | SSA16D4-D.** | |
| 16 | 0.188 | 5 | 6 | 90 | 10.5 | 8.4 | 6.7 | 5.3 | 4.2 | 3.3 | 2.5 | SSA16D5-D.** | |
| 18 | 0.125 | 4 | 4 | 40 | 1.6 | 0.9 | - | - | - | - | - | SSA18B4-D.** | |
| 18 | 0.188 | 4 | 5 | 45 | 3.6 | 2.6 | 1.9 | 1.2 | 0.7 | - | - | SSA18D4-D.** | |
| 18 | 0.250 | 4 | 5 | 55 | 5.3 | 4.1 | 3.1 | 2.3 | 1.7 | 1.1 | 0.7 | SSA18F4-D.** | |
| 18 | 0.188 | 5 | 6 | 75 | 8.0 | 6.2 | 4.8 | 3.6 | 2.6 | 1.8 | 1.2 | SSA18D5-D.** | |
| 20 | 0.125 | 4 | 4 | 40 | 0.7 | - | - | - | - | - | - | SSA20B4-D.** | |
| 20 | 0.188 | 4 | 5 | 40 | 2.4 | 1.6 | 0.9 | - | - | - | - | SSA20D4-D.** | |
| 20 | 0.250 | 4 | 5 | 45 | 3.9 | 2.8 | 2.0 | 1.3 | 0.7 | - | - | SSA20F4-D.** | |
| 20 | 0.188 | 5 | 6 | 60 | 6.0 | 4.4 | 3.1 | 2.1 | 1.3 | 0.6 | - | SSA20D5-D.** | |
| 20 | 0.250 | 5 | 6 | 80 | 8.9 | 6.9 | 5.3 | 4.0 | 2.9 | 2.1 | 1.3 | SSA20F5-D.** | |
| 20 | 0.188 | 6 | 7 | 80 | 8.7 | 6.5 | 4.7 | 3.3 | 2.1 | 1.2 | - | SSA20D6-D.** | |
| 20 | 0.250 | 6 | 7 | 115 | 12.9 | 10.0 | 7.8 | 6.0 | 4.5 | 3.3 | 2.2 | SSA20F6-D.** | |
| 25 | 0.188 | 5 | 6 | 40 | 2.1 | 0.9 | - | - | - | - | - | SSA25D5-D.** | |
| 25 | 0.250 | 5 | 6 | 50 | 4.2 | 2.7 | 1.6 | 0.6 | - | - | - | SSA25F5-D.** | |
| 25 | 0.188 | 6 | 6 | 45 | 3.4 | 1.8 | - | - | - | - | - | SSA25D6-D.** | |
| 25 | 0.250 | 6 | 7 | 70 | 6.5 | 4.4 | 2.7 | 1.4 | - | - | - | SSA25F6-D.** | |
| 25 | 0.250 | 6.625 | 8 | 95 | 9.9 | 7.1 | 4.9 | 3.1 | 1.6 | - | - | SSA25FJ-D.** | |
| 30 | 0.250 | 6 | 7 | 40 | 2.0 | - | - | - | - | - | - | SSA30F6-D.** | |
| 30 | 0.250 | 6.625 | 7 | 55 | 4.2 | 2.0 | - | - | - | - | - | SSA30FJ-D.** | |

Catalog Number System

The catalog number for Hapco poles utilizes the following identification system.

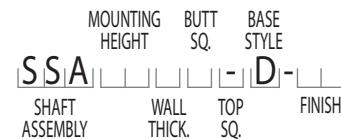

Catalog Number Example -

SSA 20 D 5 - D - BA

Square Straight Aluminum, 20' Mounting Height, .188" Wall Thickness, 5" Butt Square, No Taper, Direct Buried, Black Powder Coat Finish.

Wall Thickness

B = .125"

D = .188"

F = .250"

Butt Square

4 = 4"

5 = 5"

6 = 6"

J = 6-5/8"

Top Square

- = No Taper

Base Style

D = FBC Direct Buried

Finish

BA = Black Powder Coat

BH = White Powder Coat

BM = Dark Bronze Powder Coat

BV = Dark Green Powder Coat

GC = Gray Powder Coat

** = Specify Finish

EPA Note:

EPA's based on symmetrically placed side mounted fixture(s) not exceeding height of the pole.

Embed Note:

Embed depths shown are calculated using the weight and EPA combination corresponding to the maximum windspeed available per pole. The calculation uses the assumption of a Class 3 soil type with a 12" diameter augered hole that is to be back-filled (preferably with chloride-free concrete or high density polyurethane foam). Embed depths are subject to change if the loading changes or if the wind speed changes. Please contact Hapco for help in determining an appropriate embed depth.

SSS

Square Straight Steel Pole No Arm — 4-Bolt Base

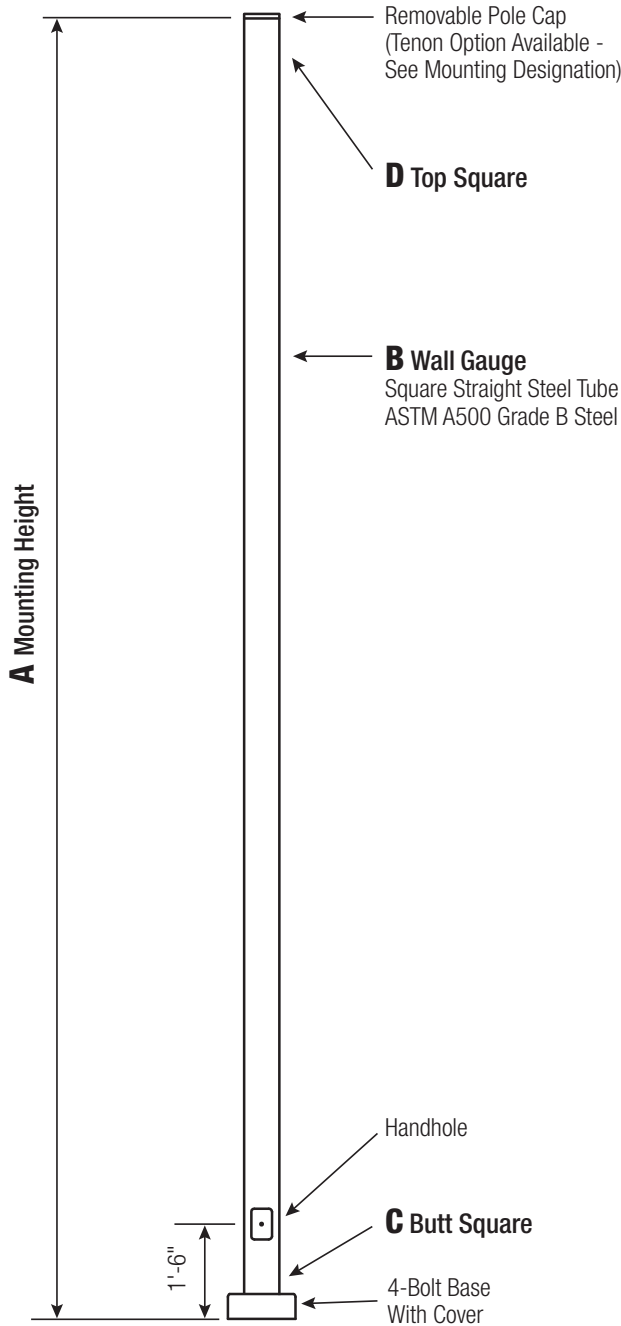

Powder Coated, Galvanized or Powder Coated over Galvanized Finish Per Customer Specification.

| C BUTT SQ. | D TOP SQ. | F BOLT CIR. DIA. | G BASE SQ. | H BOLT PROJ. | I BOLT SIZE |
|---------------|--------------|---------------------|---------------|-----------------|----------------|
| 4 (11 Gauge) | 4 | 8 - 9 | 8 | 3.75 | .75 x 17 x 3 |
| 4 (7 Gauge) | 4 | 8 - 9 | 8 | 3.75 | .75 x 30 x 3 |
| 5 (11 Gauge)* | 5 | 10 - 12 | 11 | 3.75 | .75 x 30 x 3 |
| 5 (7 Gauge) | 5 | 10 - 12 | 11 | 4.875 | 1 x 36 x 4 |
| 6 | 6 | 11 - 13 | 12.5 | 4.875 | 1 x 36 x 4 |

*Requires the use of oversized washers (provided).

Dimensions in Inches

Pole

Pole shaft shall be weldable-grade, cold-rolled, commercial quality carbon steel tubing conforming to ASTM A500 Grade B. Options include 11 gauge and 7 gauge. All Welds shall conform to AWS D1.1 using ER70S-6 electrodes.

Base Style

4-Bolt Steel Plate Base
Flange of fabricated hot rolled carbon steel conforming to ASTM A36 or equivalent (36 ksi minimum yield) with 2-piece Base Cover and attaching hardware. Base Cover will be fabricated from ABS plastic or metal materials.



Handhole

Reinforced, 3" x 5" Handhole with Cover, Stainless Steel Screw and Backbar. A Grounding Provision incorporating a tapped 1/2"-13NC hole will be welded to the handhole frame.



Anchorage

Anchorage Kit will include four (4) L-shaped Steel Anchor Bolts conforming to AASHTO M314-90 Grade 55. Ten inches (10") of threaded end will be galvanized per ASTM A153. Kits will contain eight (8) Hex Nuts, four (4) Lock Washers, and eight (8) Flat Washers (all components Galvanized Steel). A bolt circle template will be provided.

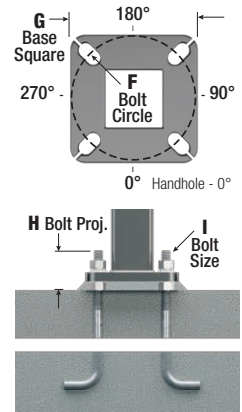

Vibration Damper

If determined necessary by Hapco, a top-mount, field installed First Mode Vibration Damper will be provided. Customer specification of the damper is available.

Mounting Designation

Side Drill Mount

For Side Drill Mount applications specify luminaire type, quantity and orientation. A luminaire drilling template must be supplied at time of order.

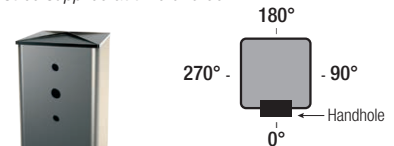

Tenon Mount

For Tenon Mount applications specify both Tenon diameter (2.375", 2.875", 3.5", 4", etc.) and length (3", 4", 5", 6", etc.).



| A MTG. HGT. | B WALL GAUGE | C BUTT SQ. | TOTAL LUM. WEIGHT | MAXIMUM EPA | | | | | | | | CATALOG NUMBER |
|-------------------|--------------------|------------------|-------------------------|-------------|------|------|-----|-----|-----|-----|-------------|----------------|
| | | | | 120 | 130 | 140 | 150 | 160 | 170 | 180 | | |
| 10 | 11 | 4 | 500 | 16.3 | 13.5 | 11.3 | 9.7 | 8.2 | 6.9 | 5.9 | SSS10B4-4** | |
| 12 | 11 | 4 | 500 | 12.6 | 10.3 | 8.4 | 7.1 | 5.9 | 4.8 | 4.0 | SSS12B4-4** | |
| 14 | 11 | 4 | 480 | 9.8 | 7.8 | 6.2 | 5.1 | 4.0 | 3.2 | 2.4 | SSS14B4-4** | |
| 15 | 11 | 4 | 400 | 8.7 | 6.8 | 5.4 | 4.3 | 3.3 | 2.5 | 1.8 | SSS15B4-4** | |
| 15 | 7 | 4 | 500 | 14.1 | 11.5 | 9.5 | 8.0 | 6.6 | 5.5 | 4.5 | SSS15D4-4** | |
| 16 | 11 | 4 | 320 | 7.8 | 6.0 | 4.6 | 3.6 | 2.7 | 1.9 | 1.4 | SSS16B4-4** | |
| 16 | 7 | 4 | 500 | 12.8 | 10.3 | 8.4 | 7.0 | 5.7 | 4.7 | 3.8 | SSS16D4-4** | |
| 18 | 11 | 4 | 240 | 5.9 | 4.3 | 3.1 | 2.3 | 1.4 | 0.8 | - | SSS18B4-4** | |
| 18 | 7 | 4 | 480 | 10.2 | 8.1 | 6.4 | 5.3 | 4.1 | 3.2 | 2.5 | SSS18D4-4** | |
| 20 | 11 | 4 | 200 | 4.2 | 2.9 | 1.8 | 1.1 | - | - | - | SSS20B4-4** | |
| 20 | 11 | 5 | 280 | 6.9 | 4.9 | 3.3 | 2.2 | 1.2 | - | - | SSS20B5-4** | |
| 20 | 7 | 4 | 400 | 8.2 | 6.3 | 4.9 | 3.8 | 2.8 | 2.0 | 1.4 | SSS20D4-4** | |
| 20 | 7 | 5 | 500 | 15.1 | 12.0 | 9.5 | 7.8 | 6.1 | 4.8 | 3.7 | SSS20D5-4** | |
| 22 | 11 | 4 | 280 | 2.6 | 1.4 | - | - | - | - | - | SSS22B4-4** | |
| 22 | 11 | 5 | 200 | 4.9 | 3.2 | 1.8 | 0.8 | - | - | - | SSS22B5-4** | |
| 22 | 7 | 4 | 200 | 6.7 | 5.1 | 3.7 | 2.8 | 1.9 | 1.2 | 0.6 | SSS22D4-4** | |
| 22 | 7 | 5 | 480 | 12.2 | 9.5 | 7.3 | 5.8 | 4.3 | 3.1 | 2.2 | SSS22D5-4** | |
| 25 | 11 | 5 | 240 | 2.2 | 0.8 | - | - | - | - | - | SSS25B5-4** | |
| 25 | 7 | 4 | 220 | 4.4 | 3.0 | 1.9 | 1.1 | - | - | - | SSS25D4-4** | |
| 25 | 7 | 5 | 280 | 9.0 | 6.7 | 4.8 | 3.5 | 2.2 | 1.2 | - | SSS25D5-4** | |
| 28 | 7 | 5 | 360 | 6.0 | 4.0 | 2.4 | 1.3 | - | - | - | SSS28D5-4** | |
| 30 | 7 | 5 | 360 | 4.3 | 2.4 | 1.0 | - | - | - | - | SSS30D5-4** | |
| 30 | 7 | 6 | 400 | 8.3 | 5.6 | 3.4 | 1.8 | - | - | - | SSS30D6-4** | |
| 35 | 7 | 5 | 200 | 1.0 | - | - | - | - | - | - | SSS35D5-4** | |
| 35 | 7 | 6 | 320 | 3.4 | 1.2 | - | - | - | - | - | SSS35D6-4** | |

Catalog Number System

The catalog number for Hapco poles utilizes the following identification system.

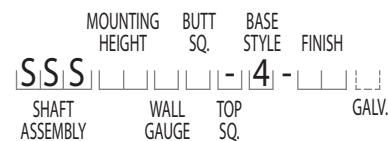

Catalog Number Example -

SSS 20 D 5 - 4 - BA

Square Straight Steel, 20' Mounting Height, 7 Gauge, 5" Butt Square, No Taper, 4-Bolt Base, Black Powder Coat Finish.

Wall Gauge

B = 11 Gauge
D = 7 Gauge

Butt Square

4 = 4"
5 = 5"
6 = 6"

Top Square

- = No Taper

Base Style

4 = 4-Bolt Anchor Base

Finish

BA = Black Powder Coat
BH = White Powder Coat
BM = Dark Bronze Powder Coat
BV = Dark Green Powder Coat
GC = Gray Powder Coat
** = Specify Finish
00 = Galvanized Only (No Powder Coat)

Galvanization

G = Galvanized

Code "G" to be used only if pole is to be Galvanized



ABS plastic base covers are standard in all SSS poles specified in BA-Black, BM-Dark Bronze, and BH-White. SSS poles specified in all other colors will be manufactured of metal materials. Metal Base Covers for poles in BA, BM and BH can be specified.

EPA Note:

EPA's based on symmetrically placed side mounted fixture(s) not exceeding height of the pole.

Proven Performance

Hapco standard and decorative aluminum products

are used in various applications in the Commercial, Utility, Municipality, and Department of Transportation markets. For over 60 years, Hapco has been considered a leader in the light pole industry and has products in every state of the US, Puerto Rico, and several international countries. Our history of proven performance, coupled with our exclusive Lifetime Warranty on aluminum pole assemblies, make Hapco the trusted industry source.

A partial listing of our customers is shown below:



*Venetian Causeway
Miami, FL
Installed Circa 1951*

Utility

Alabama Power
Alliant Energy
American Electric Power
Austin Energy
Baltimore Gas & Electric
Bristol Tennessee Essential Services
Bristol Virginia Utilities
Brownstown Electric
Chattanooga Power Board
Colorado Springs Utility
Consumers Energy
Dayton Power & Light
Detroit Energy
Dominion Power
Duke Energy
Electric Services
Entergy
First Energy
Harrisonburg Electric Commission
Huntsville Utilities
Indianapolis Power & Light
Jackson Electric Authority
Johnson City Power Board
Kentucky Utilities
Knoxville Utility Board
Louisville Gas & Electric
Mississippi Power Company
Nashville Electric Commission
National Grid
Niagara Mohawk
Northeast Utilities
Ocala Utilities Board
Orlando Utilities Commission
Pacific Gas & Electric
Progress Energy
PSE & G
Public Services of New Mexico
Puget Sound Energy
South Carolina Electric & Gas
Southern Company
Tampa Electric Company
Virginia Tech Electric
Xcel Energy

Light Fixture Manufacturers

GE Lighting
Holophane
Hubbell
Lithonia

Department of Transportation

Alabama
Arizona
California
Colorado
Connecticut
Florida
Georgia
Hawaii
Illinois
Indiana
Kansas
Kentucky
Louisiana
Maine
Maryland
Massachusetts
Michigan
Minnesota
Mississippi
Nevada
New Jersey
New Mexico
New York
North Carolina
Ohio
Oregon
Pennsylvania
Rhode Island
South Carolina
Tennessee
Texas
Virginia
Washington
Wisconsin

Municipalities

Albuquerque, New Mexico
Atlanta, Georgia
Austin, Texas
Baltimore, Maryland
Birmingham, Alabama
Champagne, Illinois
Charleston, South Carolina
Chattanooga, Tennessee
Chicago, Illinois
College Station, Texas
Colorado Springs, Colorado
Columbus, Ohio
Dayton, Ohio
Des Moines, Iowa
Eau Claire, Wisconsin
Fargo, North Dakota
Fort Wayne, Indiana
Grand Forks, North Dakota
Greenville, South Carolina
Gulfport, Mississippi
Huntsville, Alabama
Indianapolis, Indiana
Jacksonville, Florida
Kansas City, Kansas/Missouri
Knoxville, Tennessee
Las Cruces, New Mexico
Lexington, Kentucky
Louisville, Kentucky
Madison, Wisconsin
Milwaukee, Wisconsin
Minneapolis, Minnesota
Mobile, Alabama
Nashville, Tennessee
New York, New York
Ocala, Florida
Ogden, Utah
Orlando, Florida
Park City, Utah
Pensacola, Florida
Philadelphia, Pennsylvania
Savannah, Georgia
Seattle, Washington
Tacoma, Washington
Tampa, Florida
Numerous Co-Ops and
Metered Municipalities

Military Bases

Brookley AFB
Camp Lejeune
Elgin AFB
Fort Benning
Fort Bliss
Fort Bragg
Fort Campbell
Fort Carson
Fort Drum
Fort Gordon
Fort Huachuca
Fort Jackson
Fort Lee
Fort Riley
Fort Rucker
Fort Sill
Fort Stewart
Grand Forks AFB
Kings Bay Naval Base
MacDill AFB
White Sands Missile Base



***Hapco Aluminum, a sustainable material
for now and the future!***

Hapco Aluminum - The Green Choice

Hapco Aluminum provides an environmentally responsible choice of material and approach with the burgeoning green movement, allowing specifiers to aggressively pursue a design based upon sustainable principles.

Hapco Aluminum resists the ravages of time, temperature, corrosion, humidity, and warping, creating an incredibly long life cycle when compared to alternative materials. This results in a far lower environmental impact through reduced material replacement energy.

Our products are engineered to be efficiently and durably built using materials and processes that are kind to our environment. Aluminum production, unlike the galvanization process of steel which emits zinc chloride and ammonium chloride into the atmosphere, has a low impact on the environment, making it especially appealing when both environmental and economic criteria are considered.

The longevity and durability of aluminum pole products manufactured by Hapco can be validated by our industry-leading **Lifetime Warranty on Aluminum Pole Assemblies**, making Hapco Aluminum **"The Green Choice"** for today's environmentally-conscience designer.

- *Aluminum is 100% recyclable. In fact, 70% of aluminum produced since the year 1886 is still in use today.*
- *Recycling aluminum saves 95% of the energy it would take to produce new material from Bauxite Ore.*
- *Every ton of recycled aluminum saves 4 tons of the raw Bauxite required to produce new aluminum.*
- *Using recycled aluminum in place of raw materials reduces air pollution by 95% and water consumption by 97%.*
- *Aluminum is naturally corrosion-resistant, eliminating the use of toxic chemicals to maintain its appearance.*
- *Aluminum recycling benefits present and future generations by conserving energy and other natural resources.*



LIGHT POLES

Florida Building Code Guide

2017 FBC EPA's



26252 Hillman Highway
Abingdon, VA 24210
800.368.7171

www.hapco.com
email: info@hapco.com

HF-301 (10-22) ©2022 HAPCO



Proudly Supporting Our Industry...

American Welding Society
AWS D1.2 Committee

*American Association of State Highway
and Transportation Officials*
AASHTO NCHRP

National Electrical Manufacturers Society
NEMA ANSI C136
Accredited Standards Committee